



Multi-function Cutter Series

PMD

Volume 2



KEY FEATURES: PHOENIX PMD

Supports a wide range of applications with a single tool

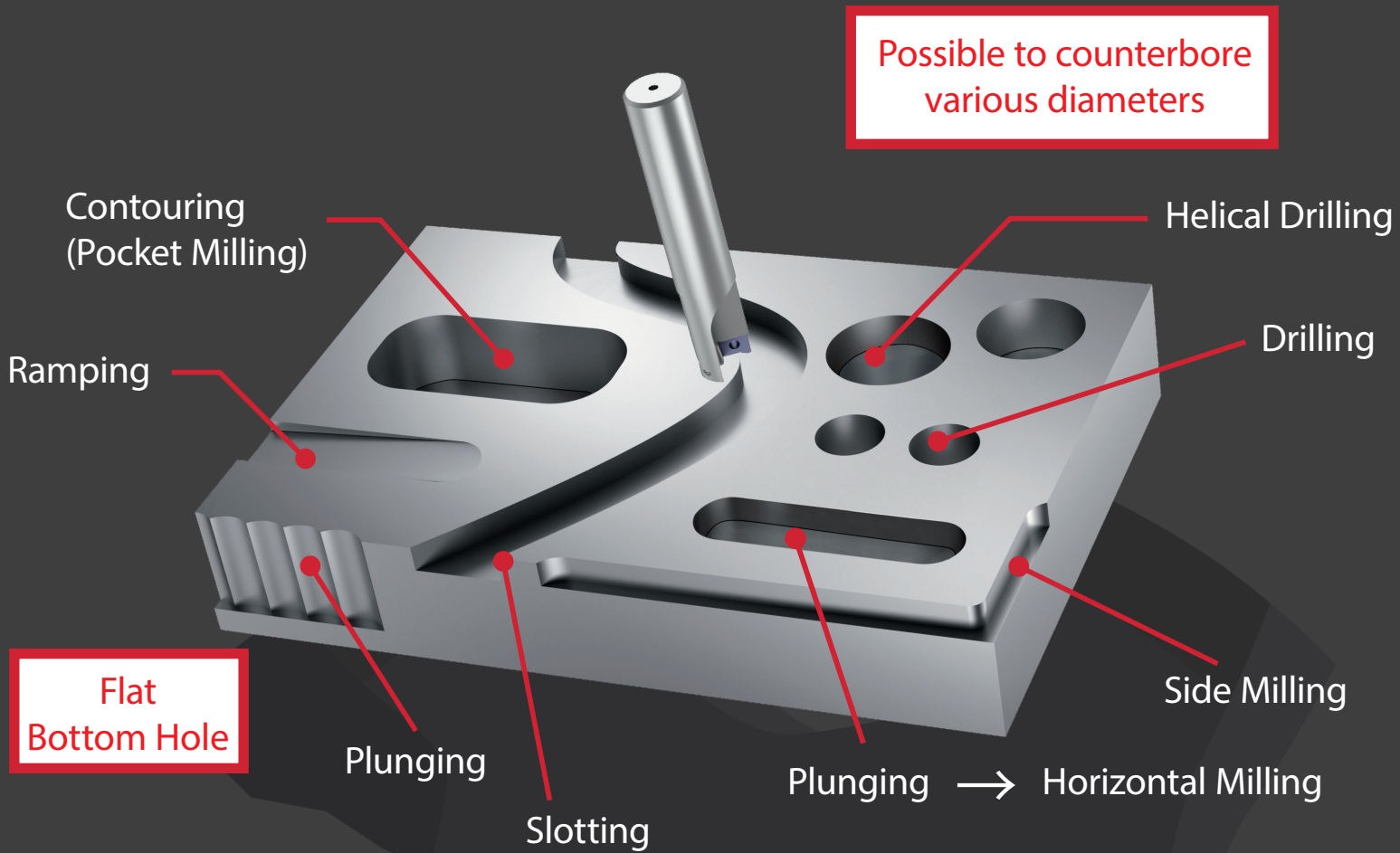

Two types of inserts are used to enable continuous cutting - from plunging to horizontal milling

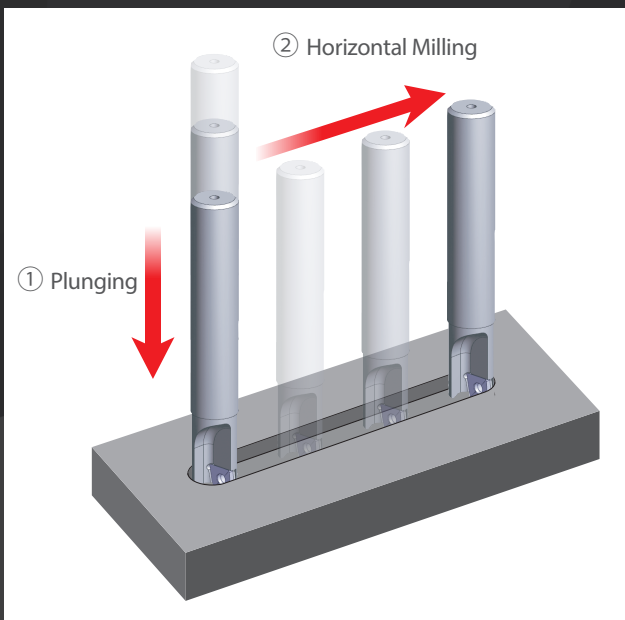

Inserts for Drilling and Plunging Edge



Superior chip breaking capability for stable machining without chip trouble. Uses the same insert as the PZAG counterboring cutter.

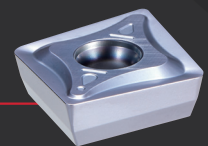

Insert for Peripheral Cutting Edge



High rigidity and sharp cutting edge ensure stable long tool life without chattering. Uses the same insert as the PSE shoulder cutter.

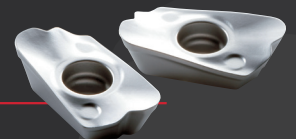

PROCESSING DATA

Milling | Indexables

Flat Bottom Hole

Tool	PMD11R025SS25-1S (Ø25 x 1 flutes)	Competitor A (Ø25 x 2 flutes)	Competitor B (Ø25 x 2 flutes)
Insert Grade	Center Insert: ZPNT130508EN (XP8030) Peripheral Insert: ZDKT11T308SR-GM (XC3030)	-	-
Milling Method	Helical Drilling		
Work Material	S50C		
Cutting Speed	150m/min(1.910 min ⁻¹)		
Feed	84mm/min (0,2mm/t)	84mm/min (0,1mm/t)	
Depth of Cut	ap=20mm		
Processing angle	2,8° (Helical Pitch)		
Coolant	None (Air Blow)		
Machine	Vertical Machining Center		

Bottom Hole Shape Comparison

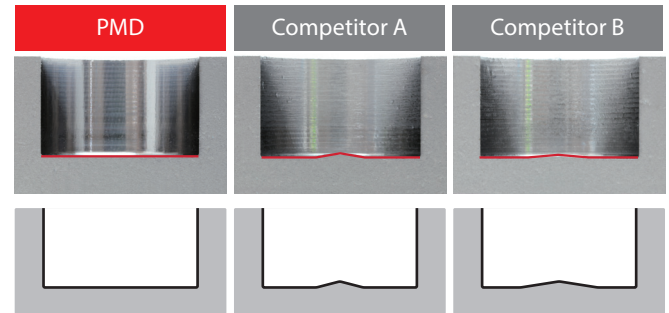

Superior chip breaking capability during drilling and plunging

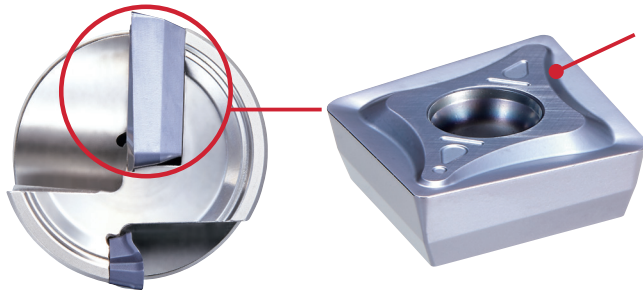

Excellent chip breaking capability with the enhanced muscle breaker

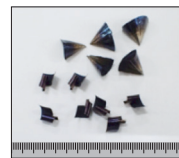

Ø25 hole processing
(non-step drilling)
Work material: S50C

Insert lineup corresponding to individual application needs

Work Material	Insert Grade for Drilling and Plunging Edge	Insert Grades for Peripheral Cutting Edge	
Steel P	XP8030	WET XP3035	DRY XC3030
Stainless Steel M		XP2040	
Cast Iron K		WET XP3025	DRY XC1015
Non-ferrous N		CK010	
Heat-resistant Alloy S		XC5040	
High Hardness Material H		XP6015	



PMD SS NEW SIZES

Milling | Indexable | 90 degrees



- 90° multi-function cutter
- 2 types of inserts (PSE & PZAG)
- Cylindrical type, with internal coolant
- 16 - 32 mm

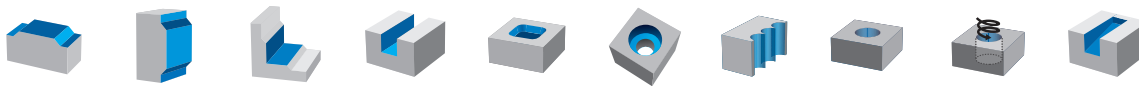
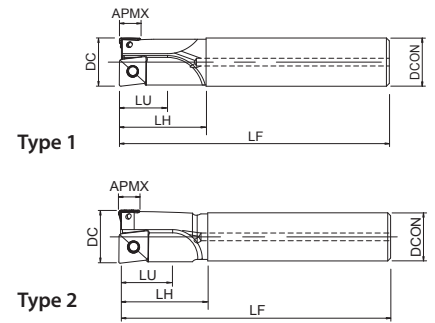

EDP	Designation	ZEFP	DC	LF	LH	APMX	DCON	LU	NOF	Applicable center inserts type	Peripheral inserts	Type
7803419 <small>NEW</small>	PMD07R016SS16-1S	1	16	100	30	6	16	16	2	ZPNT080304EN	ZDKT070304...	1
7803420 <small>NEW</small>	PMD07R016SS16-1L	1	16	150	50	6	16	16	2	ZPNT080304EN	ZDKT070304...	1
7803421 <small>NEW</small>	PMD07R018SS16-1S	1	18	100	30	6	16	18	2	ZPNT090404EN	ZDKT070304...	2
7803422 <small>NEW</small>	PMD07R018SS16-1L	1	18	150	30	6	16	18	2	ZPNT090404EN	ZDKT070304...	2
7803410	PMD11R020SS20-1S	1	20	130	35	10	20	20	2	ZPNT100408EN	ZDKT11T308...	1
7803413	PMD11R020SS20-1L	1	20	185	60	10	20	20	2	ZPNT100408EN	ZDKT11T308...	1
7803411	PMD11R025SS25-1S	1	25	140	45	10	25	25	2	ZPNT130508EN	ZDKT11T308...	1
7803414	PMD11R025SS25-1L	1	25	220	75	10	25	25	2	ZPNT130508EN	ZDKT11T308...	1
7803412	PMD11R032SS32-1S	1	32	150	50	10	32	28	2	ZPNT170608EN	ZDKT11T308...	1
7803415	PMD11R032SS32-1L	1	32	230	90	10	32	28	2	ZPNT170608EN	ZDKT11T308...	1

Milling | Indexable



90 degrees

Accessories and spare parts

Applicable cutter DC	EDP	Designation	Insert	Torque	Specification
16	7808135	FS30570P (Torx 9IP)	ZPNT08	2,2 N.m	Clamping screw
18	7808135	FS30570P (Torx 9IP)	ZPNT09	2,2 N.m	Clamping screw
20	7808137	FS35586P (Torx 15IP)	ZPNT10	3,2 N.m	Clamping screw
16-18	7808099	FS18637P (Torx 6Ip)	ZDKT07	0,5 N.m	Clamping screw
20-32	7808107	FS25656P (Torx 8IP)	ZDKT11	1,6 N.m	Clamping screw
20	7808115	FS35686P (Torx 15IP)	ZPNT10	3,2 N.m	Clamping screw
25	7808114	FS45510P (Torx 20IP)	ZPNT13	5,0 N.m	Clamping screw
32	7808114	FS45510P	ZPNT17	5,0 N.m	Clamping screw
20 - 32	7808225	8IP-D (Torx 8IP)	ZDKT11	-	Wrench
16	7808226	9IP-D (Torx 9IP)	ZPNT08	-	Wrench
18	7808226	9IP-D (Torx 9IP)	ZPNT09	-	Wrench
20	7808228	15IP-D (Torx 15IP)	ZPNT10	-	Wrench
25	7808229	20IP-D (Torx 20IP)	ZPNT13	-	Wrench
32	7808229	20IP-D (Torx 20IP)	ZPNT17	-	Wrench
16 - 18	7808223	6IP-D (Torx 6IP)	ZDKT07	-	Wrench

PMD SCREW FIT NEW SIZES

Milling | Indexable | 90 degrees

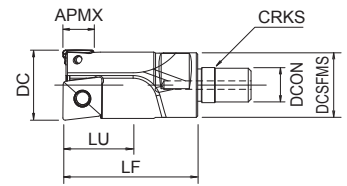
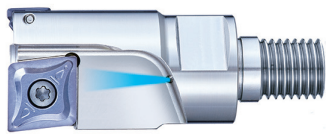

- 90° multi-function cutter
- 2 types of inserts (PSE & PZAG)
- Screw fit type
- 16 - 32 mm

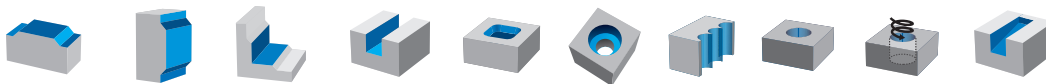

EDP	Designation	ZEFP	DC	LF	APMX	DCON	DCSFMS	DN	LU	NOF	CRKS	Wrench size	Applicable center inserts type	Peripheral inserts	Applicable shank
7803423 <small>NEW</small>	PMD07R016SF8-1	1	16	40	6	8,5	14,5	15,4	16	2	8	10	ZPNT080304EN	ZDKT070304...	③
7803424 <small>NEW</small>	PMD07R018SF8-1	1	18	40	6	8,5	14,5	17	18	2	8	10	ZPNT090404EN	ZDKT070304...	③
7803416	PMD11R020SF10-1	1	20	48	10	10,5	18	18	20	2	10	14	ZPNT100408EN	ZDKT11T308...	④
7803417	PMD11R025SF12-1	1	25	48	10	12,5	23	22	25	2	12	17	ZPNT130508EN	ZDKT11T308...	⑤
7803418	PMD11R032SF16-1	1	32	58	10	17	28	27	28	2	16	22	ZPNT170608EN	ZDKT11T308...	⑥

Accessories and spare parts

Applicable cutter DC	EDP	Designation	Insert	Torque	Specification
16	7808135	FS30570P (Torx 9IP)	ZPNT08	2,2 N.m	Clamping screw
18	7808135	FS30570P (Torx 9IP)	ZPNT09	2,2 N.m	Clamping screw
20	7808137	FS35586P (Torx 15IP)	ZPNT10	3,2 N.m	Clamping screw
16-18	7808099	FS18637P (Torx 6Ip)	ZDKT07	0,5 N.m	Clamping screw
20-32	7808107	FS25656P (Torx 8IP)	ZDKT11	1,6 N.m	Clamping screw
20	7808115	FS35686P (Torx 15IP)	ZPNT10	3,2 N.m	Clamping screw
25	7808114	FS45510P (Torx 20IP)	ZPNT13	5,0 N.m	Clamping screw
32	7808114	FS45510P	ZPNT17	5,0 N.m	Clamping screw
20 - 32	7808225	8IP-D (Torx 8IP)	ZDKT11	-	Wrench
16	7808226	9IP-D (Torx 9IP)	ZPNT08	-	Wrench
18	7808226	9IP-D (Torx 9IP)	ZPNT09	-	Wrench
20	7808228	15IP-D (Torx 15IP)	ZPNT10	-	Wrench
25	7808229	20IP-D (Torx 20IP)	ZPNT13	-	Wrench
32	7808229	20IP-D (Torx 20IP)	ZPNT17	-	Wrench
16 - 18	7808223	6IP-D (Torx 6IP)	ZDKT07	-	Wrench



PMD INSERTS NEW SIZES

Milling | Indexables

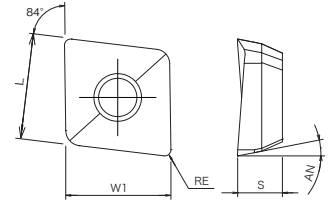

Inserts for Drilling and Plunging Edge

No.	EDP	Designation	No. of Cutting Edge	Insert Size				Appl. Body	Grade	P		M		K		N		S		H		Price
				L x W1	S	AN	RE			dry	⊕	dry	⊕	GG	GGG	dry	⊕	dry	⊕	dry	⊕	
										⊕	⊕	⊕	⊕	⊕	⊕	⊕	⊕	⊕	⊕			
①	7814105	NEW ZPNT080304EN	2	8,85x8,85	3,92	11°	0,4	Ø16	XP8030	⊕	⊕	⊕	⊕	⊕	⊕	⊕	⊕	⊕	⊕	⊕		
②	7814106	NEW ZPNT090404EN	2	9,94x9,94	4,65	11°	0,4	Ø18	XP8030	⊕	⊕	⊕	⊕	⊕	⊕	⊕	⊕	⊕	⊕	⊕		
③	7814108	ZPNT100408EN	2	10,95x10x95	4,65	11°	0,8	Ø20	XP8030	⊕	⊕	⊕	⊕	⊕	⊕	⊕	⊕	⊕	⊕	⊕		
④	7814110	ZPNT130508EN	2	13,92x13,92	5,46	11°	0,8	Ø25	XP8030	⊕	⊕	⊕	⊕	⊕	⊕	⊕	⊕	⊕	⊕	⊕		
⑤	7814111	ZPNT170608EN	2	17,85x17,85	6,31	11°	0,8	Ø32	XP8030	⊕	⊕	⊕	⊕	⊕	⊕	⊕	⊕	⊕	⊕	⊕		

Only the inserts listed above are applicable for PMD.

⊕ Best ⊕ Good

Milling | Indexables

Insert

PZAG

Inserts for the drilling and plunging edge are also applicable to the PZAG counterboring cutter (excluding ZPNT100408).

PZAG is recommended for those seeking even greater counterboring efficiency.

※ For PMD, only corner R (RE) size 0.8 can be used.



PZAG

Please refer to the Chamfering and Counterboring Catalog for details of PZAG.

PMD INSERTS NEW SIZES

Milling | Indexables

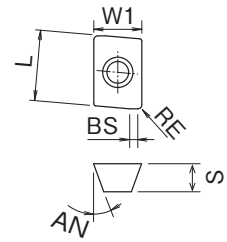

- Inserts for Peripheral Cutting Edge

EDP	Designation	No. of Cutting Edge	Insert Size					Grade	P		M		K		N		S		H		Price
			L x W1	S	AN	RE	BS		dry	⊖	dry	⊖	GG	GGG	dry	⊖	dry	⊖	dry	⊖	
7811113	^{NEW} ZDKT070304FR-NM	2	8,2x4	2,54	15°	0,4	0,9	CK010								●					
7811023	ZDKT11T308FR-NM	2	11x6,8	3,8	15°	0,8	1,4	CK010							●						
7827026	ZDKT11T308SR-GL	2	11x6,8	3,8	15°	0,8	1,4	XC3020	●				○	○							
7827032	ZDKT11T308SR-GM	2	11x6,8	3,8	15°	0,8	1,4	XC3020	●				○	○							
7827033	ZDKT11T308SR-GR	2	11x6,8	3,8	15°	0,8	1,4	XC3020	●				○	○							
7828026	ZDKT11T308SR-GL	2	11x6,8	3,8	15°	0,8	1,4	XP3025		●			○	○							
7828032	ZDKT11T308SR-GM	2	11x6,8	3,8	15°	0,8	1,4	XP3025		●			○	○							
7828033	ZDKT11T308SR-GR	2	11x6,8	3,8	15°	0,8	1,4	XP3025		●			○	○							
7825127	^{NEW} ZDKT070304SR-GL	2	8,2x4	2,54	15°	0,4	0,9	XC3030	●				○	○							
7825128	^{NEW} ZDKT070304SR-GM	2	8,2x4	2,54	15°	0,4	0,9	XC3030	●				○	○							
7825026	ZDKT11T308SR-GL	2	11x6,8	3,8	15°	0,8	1,4	XC3030	●				○	○							
7825032	ZDKT11T308SR-GM	2	11x6,8	3,8	15°	0,8	1,4	XC3030	●				○	○							
7825033	ZDKT11T308SR-GR	2	11x6,8	3,8	15°	0,8	1,4	XC3030	●				○	○							
7814123	^{NEW} ZDKT070304SR-GL	2	8,2x4	2,54	15°	0,4	0,9	XP3035	●	●	○	○	○	○							
7814124	^{NEW} ZDKT070304SR-GM	2	8,2x4	2,54	15°	0,4	0,9	XP3035	●	●	○	○	○	○							
7814026	ZDKT11T308SR-GL	2	11x6,8	3,8	15°	0,8	1,4	XP3035	●	●	○	○	○	○							
7814032	ZDKT11T308SR-GM	2	11x6,8	3,8	15°	0,8	1,4	XP3035	●	●	○	○	○	○							
7814033	ZDKT11T308SR-GR	2	11x6,8	3,8	15°	0,8	1,4	XP3035	●	●	○	○	○	○							
7826121	^{NEW} ZDKT070304SR-GL	2	8,2x4	2,54	15°	0,4	0,9	XP2025		○		●					○				
7826026	ZDKT11T308SR-GL	2	11x6,8	3,8	15°	0,8	1,4	XP2025		○		●					○				
7826032	ZDKT11T308SR-GM	2	11x6,8	3,8	15°	0,8	1,4	XP2025		○		●					○				
7813117	^{NEW} ZDKT070304SR-GL	2	8,2x4	2,54	15°	0,4	0,9	XP2040	○	○	○	○	○				○		○		
7813118	^{NEW} ZDKT070304SR-GM	2	8,2x4	2,54	15°	0,4	0,9	XP2040	○	○	○	○	○				○		○		
7813026	ZDKT11T308SR-GL	2	11x6,8	3,8	15°	0,8	1,4	XP2040	○	○	○	○	○				○		○		
7813032	ZDKT11T308SR-GM	2	11x6,8	3,8	15°	0,8	1,4	XP2040	○	○	○	○	○				○		○		
7813033	ZDKT11T308SR-GR	2	11x6,8	3,8	15°	0,8	1,4	XP2040	○	○	○	○	○				○		○		
7812114	^{NEW} ZDKT070304SR-GM	2	8,2x4	2,54	15°	0,4	0,9	XC1015					●	●							
7812033	ZDKT11T308SR-GR	2	11x6,8	3,8	15°	0,8	1,4	XC1015					●	●							
7815031	ZDKT11T308ER-SM	2	11x6,8	3,8	15°	0,8	1,4	XC5035			●	○					○				
7816031	ZDKT11T308ER-SM	2	11x6,8	3,8	15°	0,8	1,4	XC5040				○					●				
7824035	ZDKT11T308SR-HR	2	11x6,8	3,8	15°	0,8	1,4	XP6015	○				○	○					●		

Only the inserts listed above are applicable for PMD.

● Best ○ Good

PSE

Inserts for the peripheral cutting edge are applicable for the PSE shoulder milling cutter.

A wide variety of shoulder cutters that can be used for various milling operations.

※ For PMD, only corner R (RE) size 0.8 can be used.



PSE
OSG PHOENIX

Please refer to the OSG PHOENIX Catalog for details of PSE.

OP-SFA

Milling | Indexable

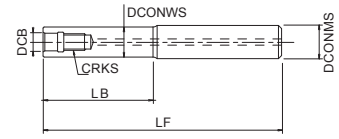

- Arbor for Screw fit type

Milling | Indexable



	EDP	Designation	LF	LB	DCON	DCONWS	DCB	CRKS	Specification
①	7801904	SF-M06SS10-4	104	4	10	9	6,5	6	Steel
②	7801905	SF-M06SS12-10	104	10	12	11	6,5	6	Steel
③	7801900	SF-M08SS16-15	95	15	16	14,5	8,5	8	Steel
④	7801901	SF-M10SS20-20	120	20	20	18	10,5	10	Steel
⑤	7801902	SF-M12SS25-35	135	35	25	23	12,5	12	Steel
⑥	7801903	SF-M16SS32-35	155	35	32	28	17	16	Steel
①	7801918	SF-M06SS10-24CS	124	24	10	9	6,5	6	Carbide
②	7801919	SF-M06SS12-34CS	134	34	12	11	6,5	6	Carbide
③	7801910	SF-M08SS16-55CS	115	55	16	14,5	8,5	8	Carbide
③	7801911	SF-M08SS16-85CS	145	85	16	14,5	8,5	8	Carbide
④	7801912	SF-M10SS20-70CS	140	70	20	18	10,5	10	Carbide
④	7801913	SF-M10SS20-110CS	180	110	20	18	10,5	10	Carbide
⑤	7801914	SF-M12SS25-90CS	170	90	25	23	12,5	12	Carbide
⑤	7801915	SF-M12SS25-140CS	220	140	25	23	12,5	12	Carbide
⑥	7801916	SF-M16SS32-120CS	220	120	32	28	17	16	Carbide
⑥	7801917	SF-M16SS32-190CS	290	190	32	28	17	16	Carbide

CUTTING CONDITIONS

Milling | Indexables

Side Milling - Slot Milling

For horizontal milling, calculate by per tooth.

Work Material	Tensile Strength / Hardness	Side Milling ap: 6mm ae: 0,15D Ø 16, 18		Side Milling ap: 10mm ae: 0,2D Ø 20, 25, 32		Slot Milling ap: 2mm ae: 1,0D Ø 16, 18		Slot Milling ap: 3mm ae: 1,0D Ø 20, 25, 32		
		Cutting Speed Vc (m/min)	Feed per tooth fz (mm/t)	Cutting Speed Vc (m/min)	Feed per tooth fz (mm/t)	Cutting Speed Vc (m/min)	Feed per tooth fz (mm/t)	Cutting Speed Vc (m/min)	Feed per tooth fz (mm/t)	
P	Mild Steel-Carbon Steel (S5400-S10C)	~180HB	180 (100~250)	0,15 (0,1~0,2)	180 (100~250)	0,25 (0,2~0,5)	180 (100~250)	0,07 (0,05~0,09)	180 (100~250)	0,12 (0,05~0,2)
	Carbon Steel-Alloy Steel (S50C-SCM440)	~280HB	180 (100~250)	0,15 (0,1~0,2)	180 (100~250)	0,2 (0,15~0,4)	180 (100~250)	0,07 (0,05~0,09)	180 (100~250)	0,11 (0,05~0,2)
	Die Steel (SKD11-SKD61)	~280HB	150 (80~200)	0,15 (0,1~0,2)	150 (80~200)	0,2 (0,15~0,4)	150 (80~200)	0,06 (0,05~0,08)	150 (80~200)	0,1 (0,05~0,18)
M	Stainless Steel (Dry) (SUS304-SUS420)	~250HB	150 (80~200)	0,12 (0,1~0,2)	150 (80~200)	0,18 (0,15~0,4)	150 (80~200)	0,06 (0,05~0,08)	150 (80~200)	0,1 (0,05~0,18)
	Stainless Steel (Wet) (SUS304,SUS420)	~250HB	80 (60~120)	0,12 (0,1~0,2)	80 (60~120)	0,18 (0,15~0,4)	80 (60~120)	0,06 (0,05~0,08)	80 (60~120)	0,1 (0,05~0,18)
K	Cast Iron (FC250)	~350N/mm ²	180 (100~300)	0,18 (0,12~0,25)	180 (100~300)	0,25 (0,15~0,5)	180 (100~300)	0,1 (0,05~0,12)	180 (100~300)	0,12 (0,05~0,2)
	Ductile Cast Iron (FCD400)	~800N/mm ²	180 (100~250)	0,15 (0,1~0,2)	180 (100~250)	0,15 (0,1~0,4)	180 (100~250)	0,1 (0,05~0,12)	180 (100~250)	0,12 (0,05~0,2)
N	Aluminium Alloy	~13%Si	300 (200~1.500)	0,2 (0,15~0,25)	300 (200~1.500)	0,3 (0,2~0,5)	300 (200~1.500)	0,12 (0,1~0,15)	300 (200~1.500)	0,15 (0,1~0,25)
S	Superalloy (Wet) (Inconel*718)	-	35 (25~60)	0,1 (0,08~0,15)	35 (25~60)	0,15 (0,1~0,3)	35 (25~60)	0,06 (0,05~0,15)	35 (25~60)	0,1 (0,05~0,15)
	Titanium Alloy (Wet) (Ti-6Al-4V)	-	40 (30~120)	0,1 (0,08~0,15)	40 (30~120)	0,18 (0,1~0,35)	40 (30~120)	0,06 (0,04~0,07)	40 (30~120)	0,1 (0,08~0,25)
H	Pre-hardened Steel (NAK80)	40~43HRC	100 (40~150)	0,1 (0,08~0,15)	100 (40~150)	0,18 (0,1~0,3)	100 (40~150)	0,07 (0,05~0,08)	100 (40~150)	0,1 (0,08~0,2)
	Steel for Die Casting (DAC-MAGIC, DH31)	43~48HRC	80 (40~120)	0,1 (0,08~0,15)	80 (40~120)	0,12 (0,08~0,2)	80 (40~120)	0,06 (0,04~0,08)	70 (40~120)	0,08 (0,06~0,15)
	Hardened Steel (SKD11)	50~55HRC	60 (40~90)	0,08 (0,06~0,1)	60 (40~90)	0,1 (0,05~0,2)	60 (40~90)	0,05 (0,04~0,06)	50 (40~90)	0,06 (0,05~0,1)

Drilling

For both counterboring and plunge milling

Work Material	Tensile Strength / Hardness	Cutting Speed Vc (m/min)	Feed Rate f (mm/rev)					
			Ø16	Ø18	Ø20	Ø25	Ø32	
P	Mild Steel-Carbon Steel (S5400-S10C)	~180HB	160 (100~200)	0,06 (0,04~0,07)	0,06 (0,04~0,07)	0,07 (0,05~0,08)	0,08 (0,06~0,1)	0,1 (0,08~0,12)
	Carbon Steel-Alloy Steel (S50C-SCM440)	~280HB	150 (100~200)	0,06 (0,04~0,07)	0,06 (0,04~0,07)	0,07 (0,05~0,08)	0,08 (0,06~0,1)	0,1 (0,08~0,12)
	Die Steel (SKD11-SKD61)	~280HB	120 (80~180)	0,06 (0,04~0,07)	0,06 (0,04~0,07)	0,07 (0,05~0,08)	0,08 (0,06~0,1)	0,1 (0,08~0,12)
M	Stainless Steel (Dry) (SUS304-SUS420)	~250HB	130 (80~180)	0,06 (0,04~0,07)	0,06 (0,04~0,07)	0,07 (0,05~0,08)	0,08 (0,06~0,1)	0,1 (0,08~0,12)
K	Cast Iron (FC250)	~350N/mm ²	200 (150~180)	0,06 (0,04~0,07)	0,06 (0,04~0,07)	0,07 (0,05~0,08)	0,08 (0,06~0,1)	0,1 (0,08~0,12)
	Ductile Cast Iron (FCD400)	~800N/mm ²	160 (100~220)	0,06 (0,04~0,07)	0,06 (0,04~0,07)	0,07 (0,05~0,08)	0,08 (0,06~0,1)	0,1 (0,08~0,12)
N	Aluminium Alloy	~13%Si	200 (100~800)	0,06 (0,04~0,07)	0,06 (0,04~0,07)	0,07 (0,05~0,08)	0,08 (0,06~0,1)	0,1 (0,08~0,12)
S	Superalloy (Wet) (Inconel*718)	-	50 (30~60)	0,06 (0,04~0,07)	0,06 (0,04~0,07)	0,07 (0,05~0,08)	0,08 (0,06~0,1)	0,1 (0,08~0,12)
	Titanium Alloy (Wet) (Ti-6Al-4V)	-	60 (30~100)	0,06 (0,04~0,07)	0,06 (0,04~0,07)	0,07 (0,05~0,08)	0,08 (0,06~0,1)	0,1 (0,08~0,12)
H	Pre-hardened Steel (NAK80)	40~43HRC	100 (60~120)	0,06 (0,04~0,07)	0,06 (0,04~0,07)	0,07 (0,05~0,08)	0,08 (0,06~0,1)	0,1 (0,08~0,12)
	Steel for Die Casting (DAC-MAGIC, DH31)	43~48HRC	80 (40~100)	0,06 (0,04~0,07)	0,06 (0,04~0,07)	0,07 (0,05~0,08)	0,08 (0,06~0,1)	0,1 (0,08~0,12)
	Hardened Steel (SKD11)	50~55HRC	60 (40~80)	0,06 (0,04~0,07)	0,06 (0,04~0,07)	0,07 (0,05~0,08)	0,08 (0,06~0,1)	0,1 (0,08~0,12)

- * Above recommended speed is for short shank type.
For long shank type, use the following cutting condition: cutting speed = 80% of the above settings.
- The indicated speeds and feeds are for milling with water-soluble coolant.
 - The above cutting conditions are to be used as general guidelines. Adjustments may be necessary depending on actual cutting condition.
 - Inserts should be attached to the holder tightly in a very neat condition.
 - Fasten the work material to reduce the possibility of work deformation, deflection of machined surface, or vibration.

Set the maximum processing angle during ramping and helical drilling operations to less than 3°.

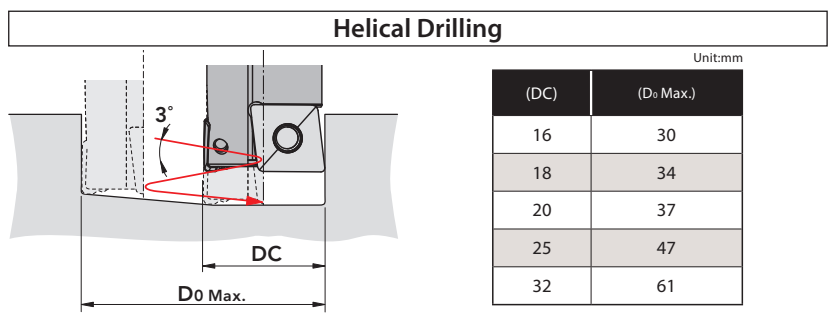
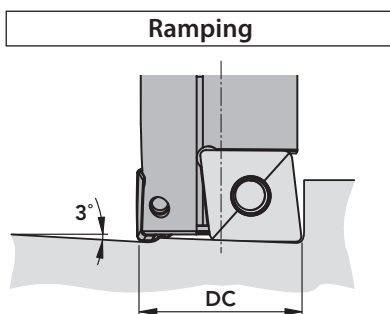

(DC)	(D0 Max.)
16	30
18	34
20	37
25	47
32	61

CUTTING DATA

Milling | Indexables

Plunging → Horizontal Milling

Tool	PMD11R025SS25-1S (Ø25 x 1 flute)	
Insert Grade	Center Insert: ZPNT130508EN (XP8030) Peripheral Insert: ZDKT11T308SR-GM (XC3030)	
Milling Method	Plunging	Horizontal Milling
Work Material	S50C	
Cutting Speed	100m/min (1.274min ⁻¹)	
Feed	102mm/min (0.08mm/rev)	204mm/min (0.16mm/t)
Depth of Cut	a _p =7mm a _e =25mm	
Coolant	None (Air Blow)	
Machine	Vertical Machining Center (BT40)	

Excellent milling surface finish without chattering.

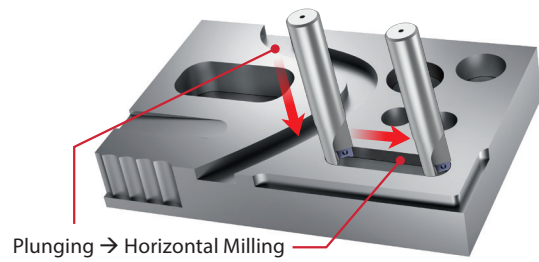

Plunging → Horizontal Milling

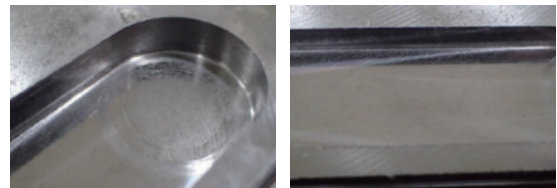

Slotting ■ Side Milling

Tool	PMD11R025SS25-1S (Ø25 x 1 flute)	
Insert Grade	Center Insert: ZPNT130508EN (XP8030) Peripheral Insert: ZDKT11T308SR-GM (XC3030)	
Milling Method	Slotting	Side Milling
Work Material	S50C	
Cutting Speed	150m/min (1.910min ⁻¹)	
Feed	382mm/min (0.2mm/t)	
Depth of Cut	a _p =7mm a _e =25mm	a _p =10mm a _e =2,5mm
Coolant	None (Air Blow)	
Machine	Vertical Machining Center (BT40)	

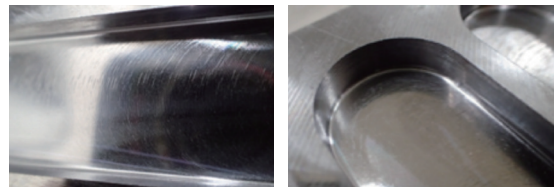
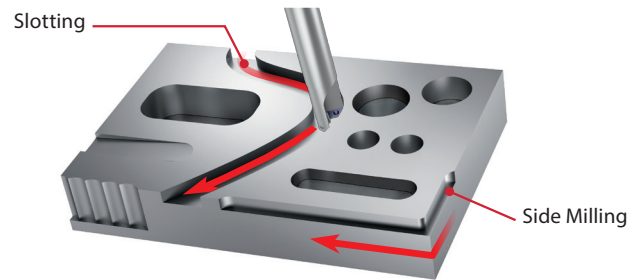

Helical Drilling ■ Ramping

Tool	PMD11R025SS25-1S (Ø25 x 1 flute)	
Insert Grade	Center Insert: ZPNT130508EN (XP8030) Peripheral Insert: ZDKT11T308SR-GM (XC3030)	
Milling Method	Helical Drilling	Ramping
Processing Angle	Helical Pitch 2,5°	3°
Work Material	S50C	
Cutting Speed	150m/min (1.910min ⁻¹)	
Feed	107mm/min (0.15mm/t)	287mm/min (0.15mm/t)
Depth of Cut	a _p =25mm	a _p =7mm
Coolant	None (Air Blow)	
Machine	Vertical Machining Center (BT40)	

No burrs at the hole entry and no leftover material in the center of hole after processing.

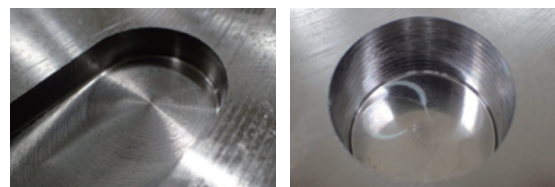

PROCESSING DATA

Milling | Indexables

Processing time reduction by continuous operation from drilling to contouring

Tool	PMD11R025SS25-1S (Ø25 x 1 flute)	Conventional carbide end mill (Ø20x 4 flutes)
Insert Grade	Center Insert: ZPNT130508EN (XP8030) Peripheral Insert: ZDKT11T308-GM (XP3035)	-
Work Material	FCV410	
Coolant	Non-Water-Soluble (Internal)	
Machine	Horizontal Machining Center	

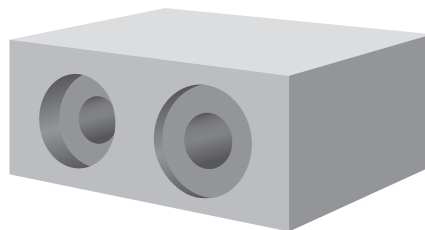

Counterboring Ø	Ø 31,8			Ø 34,8			Ø 40,8		
Processing Shape									
Tool	PMD (Ø25 x 1 flute)		Conventional (Ø20x 4 flutes)	PMD (Ø25 x 1 flute)		Conventional (Ø20x 4 flutes)	PMD (Ø25 x 1 flute)		Conventional (Ø20x 4 flutes)
Milling Method	Drilling	Contouring	Helical Drilling	Drilling	Contouring	Helical Drilling	Drilling	Contouring	Helical Drilling
Depth of Cut	15mm	ap=5mm ae=3,4mm	5mm Helical Pitch	2mm	ap=2mm ae=4,9mm	2mm Helical Pitch	2mm	ap=2mm ae=7,9mm	2mm Helical Pitch
Cutting Speed	157m/min (2.000min ⁻¹)		63m/min (1.000min ⁻¹)	157m/min (2.000min ⁻¹)		63m/min (1.000min ⁻¹)	157m/min (2.000min ⁻¹)		63m/min (1.000min ⁻¹)
Feed	350mm/min (0,175mm/rev)	75mm/min (0,175mm/t)	74mm/min (0,05mm/t)	500mm/min (0,25mm/rev)	141mm/min (0,25mm/t)	85mm/min (0,05mm/t)	500mm/min (0,25mm/rev)	194mm/min (0,25mm/t)	102mm/min (0,05mm/t)
Actual Processing time (calculated Value)	About 80 sec.		About 120 sec.	About 20 sec.		About 66 sec.	About 23 sec.		About 77 sec.

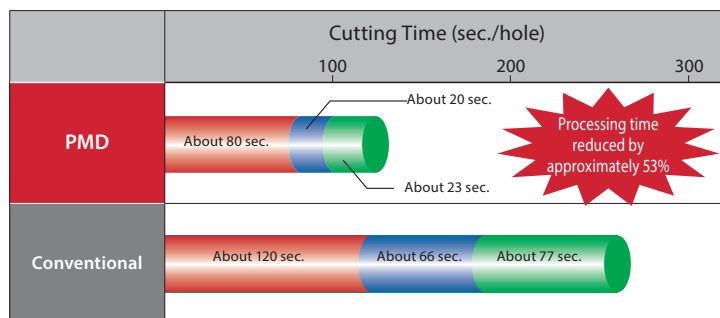

Processing time is reduced as the PMD is capable of drilling a hole and enlarging it by contouring.

- Ø31,8
- Ø34,8
- Ø40,8

High-efficiency counterboring of the casted surface is made possible

Tool	PMD11R025SS25-1S (Ø25 x 1 flute)	Competitor (Ø25 x 2 flutes)
Insert Grade	Center Insert: ZPNT130508EN (XP8030) Peripheral Insert: ZDKT11T308-SR (XC1015)	-
Work Material	FC250	
Cutting Speed	150m/min (1.909min ⁻¹)	78m/min (1.000min ⁻¹)
Feed	286mm/min (0,15mm/rev)	100mm/min (0,1mm/rev)
Counterboring Ø	Ø25	
Depth of Cut	5mm	
Coolant	None (Air Blow)	
Machine	Horizontal Machining Center (BT50)	

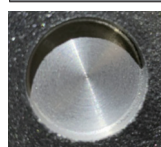
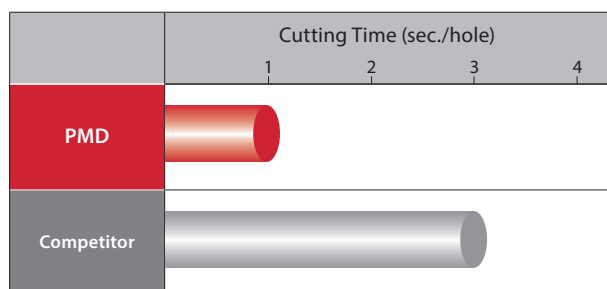

The PMD is able to achieve excellent milling surface finish and reduce processing time even on unstable rough casted surface.



shaping your dreams

OSG EUROPE LOGISTICS

Avenue Lavoisier 1
B-1300 Z.I. Wavre - Nord - Belgium
Tel: +32 10 23 05 07
Fax: +32 10 23 05 51
info@osgeurope.com

OSG BELUX

Avenue Lavoisier 1
B-1300 Z.I. Wavre - Nord - Belgium
Tel: +32 10 23 05 11
Fax: +32 10 23 05 31
info@osg-belgium.com

OSG FRANCE

Parc Icade, Paris Nord 2
Immeuble "Le Rimbaud"
22 Avenue des Nations
CS66191 - 93420 Villepinte - France
Tel: +33 1 49 90 10 10
Fax: +33 1 49 90 10 15
sales@osg-france.com

OSG NETHERLANDS

Bedrijfsweg 5 - 3481 MG Harmelen
Tel: +31 348 44 2764
Fax: +31 348 44 2144
info@osg-nl.com

OSG UK

Kelsey Close, Attleborough Fields Ind Est,
CV11 6RS, Nuneaton, United Kingdom.
Tel: +44 1827 720 013
uk_sales@osg-uk.com

CZECH, SLOVAKIA, HUNGARY

OSG Europe Logistics S.A.
Slovakia organizacna zlozka
Racianská 22/A, SK-83102 Bratislava
Slovakia
Tel. +421 24 32 91 295
Orders-osgsvk@osgeurope.com

OSG POLAND Sp. z.o.o.

Spółdzielcza 57
05-074 Halinów - Poland
Tel: +22 760 82 71
Fax: +22 760 82 71
osg@osg-poland.com

OSG GERMANY

Karl-Ehmann-Str. 25
D - 73037 Göppingen - Germany
Tel: +49 7161 6064 - 0
Fax: +49 7161 6064 - 444
info@osg-germany.de

OSG SCANDINAVIA

(For Scandinavian countries)
Langebjergvaenget 16
4000 Roskilde - Denmark
Tel: +45 46 75 65 55
Fax: +45 46 75 67 00
osg@osg-scandinavia.com

SWEDEN

Branch office of OSG SCANDINAVIA
Singelgatan 7
212 28 Malmö - Sweden
Tel: +46 40 41 22 55
osg@osg-scandinavia.com

OSG IBERICA

Bekolarra 4
E - 01010 Vitoria-Gasteiz - Spain
Tel: +34 945 242 400
Fax: +34 945 228 883
osg.iberica@osg-ib.com

RUSSIA

Butlerova street, 17B, office 5069
117342 Moscow - Russia
Tel: +7 (495) 150 41 54
info@osg-russia.com

OSG TURKEY

Rami Kişla Cad.No:56 Eyüp
Istanbul 34056 - Turkey
Tel:+90 212 565 24 00
Fax: +90 212 565 44 00
info@osg-turkey.com

ROMSAN INTERNATIONAL CO. SRL

Reprezentant Exclusiv OSG
25C, Bucuresti-Magurele Street
051431 Bucuresti - România
Tel: +40 21 322 07 47
Fax: +40 21 321 56 00
romsan.int@romsan.ro

AUSTRIA

Branch office of OSG GERMANY
Messestraße 11
A-6850 Dornbirn
Tel: +49 7161 6064-0
Fax: +49 7161 6064-444
info@osg-germany.de

OSG ITALIA

Via Ferrero, 65 A/B3
I - 10098 Rivoli - Italy
Tel: +39 0117705211
Fax: +39 0117705215
info@osg-italia.it

Vischer & Bolli AG

Machining and Workholding
Im Schossacher 17
CH-8600 Dübendorf
T +41 44 802 15 15
F +41 44 802 15 95
info@vb-tools.com

OSG EUROPE LOGISTICS S.A.

01/2023 - All rights reserved. © OSG Europe 2023.

The contents of this catalogue are provided to you for viewing only. They are not intended for reproduction either in part or in whole in this or other medium. They cannot be copied, used to create derivation work or used for any reason, by means without the express, written permission of the copyright owner. If prices are stated, they are netto unit-prices and any eventual tax(es) have to be added. The company is not responsible for any printing error in technical, price and/or any other data.

Tool specifications subject to change without notice.

www.osgeurope.com

