

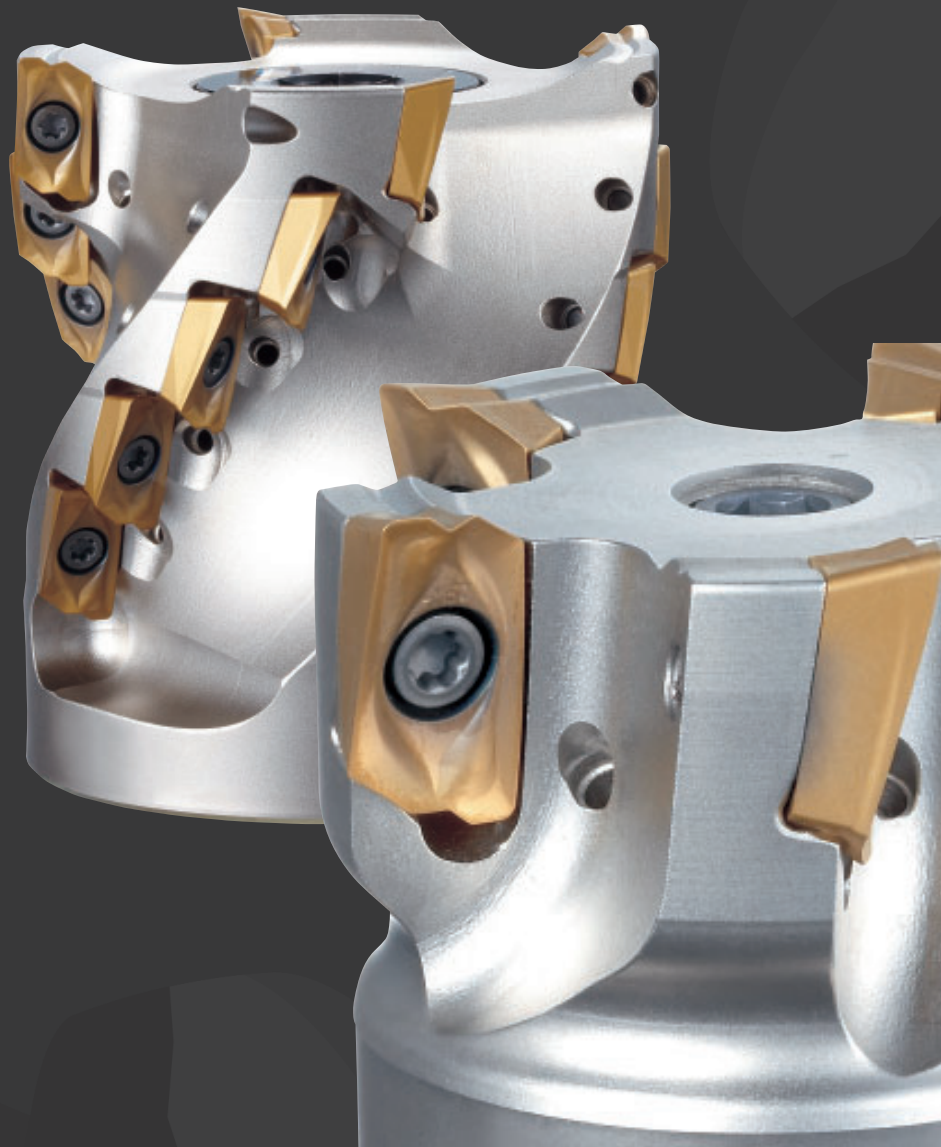

Shoulder & roughing end mill series

# PSE • PSEL

Volume 2

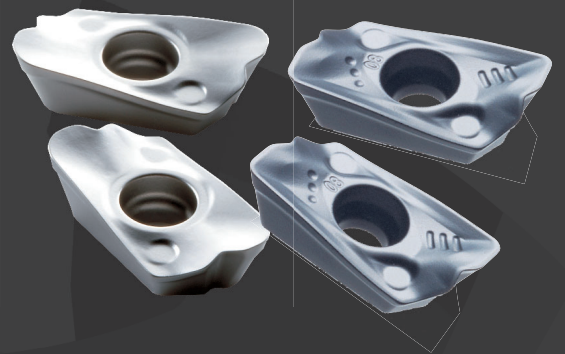

# KEY FEATURES: PHOENIX PSE

---



**1** 90° shoulder cutter

**2** 2 corners inserts with bottom notch

**3** Cylindrical type

## Bottom notch

- The bottom notch breaks chips into 2 pieces when processing ramping and helical milling.
- Preventing chip jamming or wrapping and enabling smooth process.
- The bottom notch is available in PSE11 R1.6 or less, and PSE15 R2.5 or less.

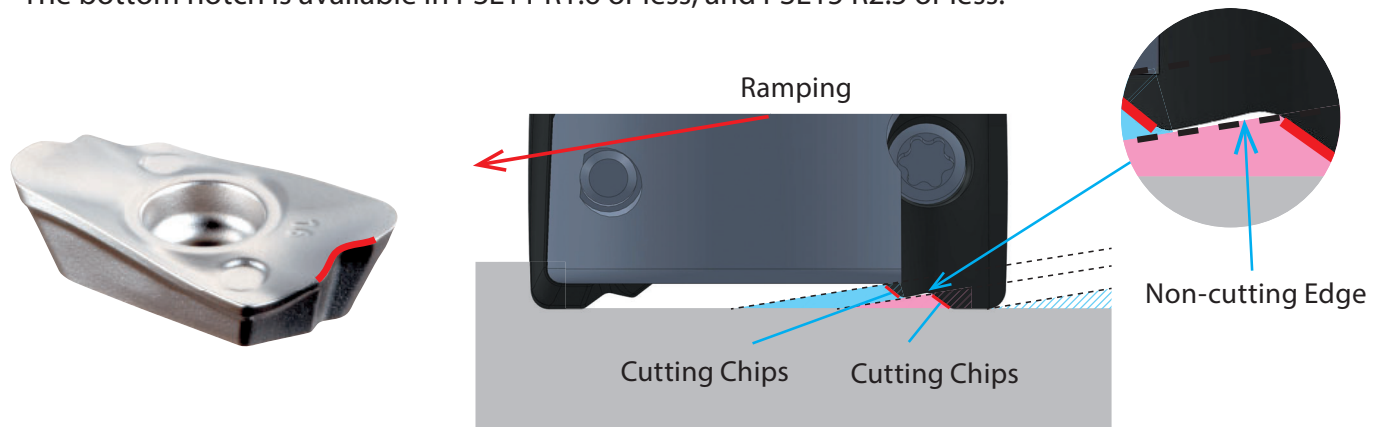

## High precision insert

	Bottom roughness	Side Milling offset
Tool	PSE11R032SS32-5S	PSE15R032SS32-3S
Insert Grade	ZDKT11T304SR-GM XP3035	ZDKT150508SR-GM XP3035
Work Material	S50C	
Cutting Conditions	Vc=180m/min fz=0,1mm/t ap=0,1mm ae=25,6mm	Vc=180m/min fz=0,1mm/t ap=5mm ae=0,2mm
Result	PSE showed an improvement at the bottom flat surface finish Rz 4µm and under.	Showed improvement at side step machining as (measured) step as 10 µm

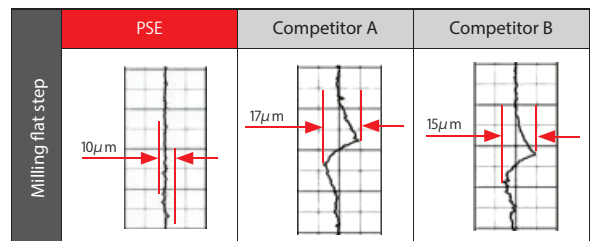
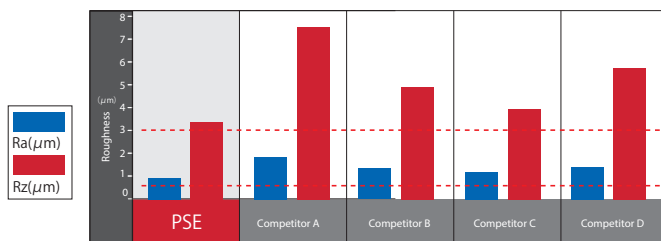

## Wide variety of inserts

Insert Breaker	NM	GL	SM	GM	GR	HR
Rake Angle	30°	25°	15°	15°	7°	3°
Application	Aluminum alloy & Non-ferrous metal	Low-resistance machining	Superalloy & Difficult-to-machine material	Multi-purpose machining	Interrupted machining & Long overhang machining	High-hardened material

# PSE WS / PSE SS NEW SIZES

Milling | Indexable | 90 degrees



- 90° shoulder cutter
- 2 corners inserts with bottom notch
- Cylindrical type, with internal coolant
- 10 - 63 mm

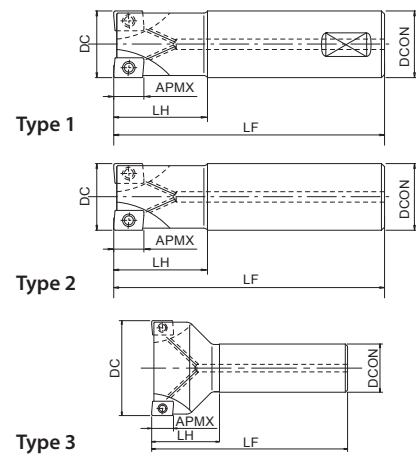

	EDP	Designation	ZEFP	DC	EDP	LF	LH	APMX	DCON	Applicable inserts type	Type
NEW	7803810	PSE07R010SS10-2S	2	10	50	12	12	6	10	ZDT07	2
NEW	7803811	PSE07R012SS12-3S	3	12	50	12	12	6	12	ZDT07	2
NEW	7803813	PSE07R016SS16-3S	3	16	90	25	25	6	16	ZDT07	2
NEW	7803814	PSE07R016SS16-4S	4	16	90	25	25	6	16	ZDT07	2
NEW	7803817	PSE07R020SS20-4S	4	20	100	30	30	6	20	ZDT07	2
NEW	7803820	PSE07R025SS25-5S	5	25	120	35	35	6	25	ZDT07	2
	47801100	PSE11R016WS16-2S	2	16	75	25	25	10	16	ZDT11	1
	7801100	PSE11R016SS16-2S	2	16	90	25	25	10	16	ZDT11	2
	7801121	PSE11R016SS16-2L	2	16	150	50	50	10	16	ZDT11	2
	7801116	PSE11R018SS16-2S	2	18	90	25	25	10	16	ZDT11	3
	7801122	PSE11R018SS16-2L	2	18	150	25	25	10	16	ZDT11	3
	47801115	PSE11R020WS20-3S	3	20	80	25	25	10	20	ZDT11	1
	7801101	PSE11R020SS20-2S	2	20	100	30	30	10	20	ZDT11	2
	7801115	PSE11R020SS20-3S	3	20	100	30	30	10	20	ZDT11	2
	7801123	PSE11R020SS20-3L	3	20	160	60	60	10	20	ZDT11	2
	7801117	PSE11R022SS20-3S	3	22	110	30	30	10	20	ZDT11	3
	7801124	PSE11R022SS20-3L	3	22	160	30	30	10	20	ZDT11	3
	47801104	PSE11R025WS25-4S	4	25	90	35	35	10	25	ZDT11	1
	7801102	PSE11R025SS25-3S	3	25	120	35	35	10	25	ZDT11	2
	7801104	PSE11R025SS25-4S	4	25	120	35	35	10	25	ZDT11	2
	7801125	PSE11R025SS25-3L	3	25	170	70	70	10	25	ZDT11	2
	7801118	PSE11R028SS25-4S	4	28	120	35	35	10	25	ZDT11	3
	7801126	PSE11R028SS25-3L	3	28	170	35	35	10	25	ZDT11	3
	7801119	PSE11R030SS32-4S	4	30	130	45	45	10	32	ZDT11	2
	7801127	PSE11R030SS32-3L	3	30	190	90	90	10	32	ZDT11	2
	47801105	PSE11R032WS32-5S	5	32	105	40	40	10	32	ZDT11	1
	7801105	PSE11R032SS32-5S	5	32	125	40	40	10	32	ZDT11	2
	7801103	PSE11R032SS32-3S	3	32	130	45	45	10	32	ZDT11	2
	7801128	PSE11R032SS32-3L	3	32	190	90	90	10	32	ZDT11	2
	7801120	PSE11R035SS32-5S	5	35	130	35	35	10	32	ZDT11	3
	7801129	PSE11R035SS32-3L	3	35	190	35	35	10	32	ZDT11	3
	47801106	PSE15R025WS25-2S	2	25	100	32	32	14	25	ZDT15	1
	7801106	PSE15R025SS25-2S	2	25	120	35	35	14	25	ZDT15	2
	7801133	PSE15R025SS25-2L	2	25	170	70	70	14	25	ZDT15	2
	7801130	PSE15R028SS25-2S	2	28	120	35	35	14	25	ZDT15	3
	7801134	PSE15R028SS25-2L	2	28	170	35	35	14	25	ZDT15	3
	7801131	PSE15R030SS32-3S	3	30	130	45	45	14	32	ZDT15	2
	7801135	PSE15R030SS32-3L	3	30	190	90	90	14	32	ZDT15	2
	47801111	PSE15R032WS32-3S	3	32	125	40	40	14	32	ZDT15	1
	7801107	PSE15R032SS32-2S	2	32	130	45	45	14	32	ZDT15	2
	7801111	PSE15R032SS32-3S	3	32	130	45	45	14	32	ZDT15	2
	7801136	PSE15R032SS32-3L	3	32	190	90	90	14	32	ZDT15	2
	7801132	PSE15R035SS32-3S	3	35	130	35	35	14	32	ZDT15	3
	7801137	PSE15R035SS32-3L	3	35	190	45	45	14	32	ZDT15	3
	7801108	PSE15R040SS32-3S	3	40	140	50	50	14	32	ZDT15	3
	7801112	PSE15R040SS32-4S	4	40	140	50	50	14	32	ZDT15	3
	7801138	PSE15R040SS32-3L	3	40	190	45	45	14	32	ZDT15	3
	7801109	PSE15R050SS32-3S	3	50	130	45	45	14	32	ZDT15	3
	7801113	PSE15R050SS32-5S	5	50	130	45	45	14	32	ZDT15	3
	7801110	PSE15R063SS32-4S	4	63	130	45	45	14	32	ZDT15	3
	7801114	PSE15R063SS32-6S	6	63	130	45	45	14	32	ZDT15	3

## Accessories and spare parts

Applicable cutter DC	EDP	Designation	Specification
PSE SS/SF 10 - 12 (ZDKT07)	7808098	FS18634P (Torx 6IP)	Clamping screw
PSE SS 16 - 26 (ZDKT07)	7808099	FS18637P (Torx 6IP)	Clamping screw
PSE SF 16 - 32 (ZDKT07)	7808099	FS18637P (Torx 6IP)	Clamping screw
PSE SS 10 - 26 (ZDKT07)	7808223	6IP-D (Torx 6IP)	Wrench
PSE SF 10 - 32 (ZDKT07)	7808223	6IP-D (Torx 6IP)	Wrench
16 - 40 (ZD-T11)	7808107	FS25656P (Torx 8IP)	Clamping screw
16 - 40 (ZD-T11)	7808225	8IP-D (Torx 8IP)	Wrench
25 - 63 (ZDKT15)	7808115	FS35686P (Torx 15IP)	Clamping screw
25 - 63 (ZDKT15)	7808228	15IP-D (Torx 15IP)	Wrench

Milling | Indexables

90 degrees

# PSE BORE

Milling | Indexable | 90 degrees

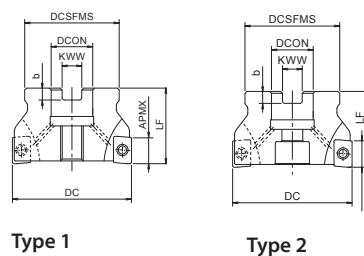

- 90° shoulder cutter
- 2 corners inserts with bottom notch
- Bore type
- 40 - 100 mm



EDP	Designation	ZEFP	DC	LF	APMX	DCON	DCSFMS	KWW	b	Applicable inserts type	Type
7801000	PSE11R040M16-4	4	40	40	10	16	38	8,4	5,6	ZDT11	1
7801004	PSE11R040M16-6	6	40	40	10	16	38	8,4	5,6	ZDT11	1
7801001	PSE11R050M22-5	5	50	40	10	22	45	10,4	6,3	ZDT11	1
7801005	PSE11R050M22-7	7	50	40	10	22	45	10,4	6,3	ZDT11	1
7801002	PSE11R063M22-6	6	63	40	10	22	50	10,4	6,3	ZDT11	2
7801006	PSE11R063M22-8	8	63	40	10	22	50	10,4	6,3	ZDT11	2
7801003	PSE11R080M27-7	7	80	50	10	27	60	12,4	7	ZDT11	2
7801007	PSE11R080M27-10	10	80	50	10	27	60	12,4	7	ZDT11	2
7801008	PSE15R040M16-3	3	40	40	14	16	38	8,4	5,6	ZDT15	1
7801014	PSE15R040M16-4	4	40	40	14	16	38	8,4	5,6	ZDT15	1
7801009	PSE15R050M22-3	3	50	40	14	22	45	10,4	6,3	ZDT15	1
7801015	PSE15R050M22-5	5	50	40	14	22	45	10,4	6,3	ZDT15	1
7801010	PSE15R063M22-4	4	63	40	14	22	50	10,4	6,3	ZDT15	2
7801016	PSE15R063M22-6	6	63	40	14	22	50	10,4	6,3	ZDT15	2
7801011	PSE15R080M27-5	5	80	50	14	27	60	12,4	7	ZDT15	2
7801017	PSE15R080M27-8	8	80	50	14	27	60	12,4	7	ZDT15	2
7801012	PSE15R100M32-7	7	100	50	14	32	70	14,4	8	ZDT15	2
7801018	PSE15R100M32-10	10	100	50	14	32	70	14,4	8	ZDT15	2

## Accessories and spare parts

Applicable cutter DC	EDP	Designation	Specification
40	7808150	PS0830 (M8x30)	Power screw
50	7808151	PS1031 (M10x31)	Power screw
40 - 80 (ZD-T11)	7808109	FS25673P (Torx 8IP)	Clamping screw
40 - 80 (ZD-T11)	7808225	8IP-D (Torx 8IP)	Wrench
40 - 125 (ZDKT15)	7808115	FS35686P (Torx 15IP)	Clamping screw
40 - 125 (ZDKT15)	7808228	15IP-D (Torx 15IP)	Wrench

Milling | Indexables



90 degrees

# PSE SCREW FIT NEW SIZES

Milling | Indexable | 90 degrees

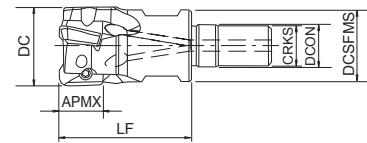

- 90° shoulder cutter
- 2 corners inserts with bottom notch
- Screw fit type
- 10 - 40 mm



EDP	Designation	ZEFP	DC	APMX	DCON	DCSFMS	LF	CRKS	Wrench size	Applicable inserts type	Applicable shank
<b>NEW</b> 7803822	PSE07R010SF6-2	2	10	6	6,5	9	26	6	7	ZD...T07...	①
<b>NEW</b> 7803823	PSE07R012SF6-3	3	12	6	6,5	11	26	6	7	ZD...T07...	②
<b>NEW</b> 7803824	PSE07R016SF8-4	4	16	6	8,5	15	27	8	10	ZD...T07...	③
<b>NEW</b> 7803825	PSE07R020SF10-4	4	20	6	10,5	18	33	10	14	ZD...T07...	④
<b>NEW</b> 7803826	PSE07R025SF12-5	5	25	6	12,5	23	35	12	17	ZD...T07...	⑤
<b>NEW</b> 7803827	PSE07R032SF16-6	6	32	6	17	17	35	16	22	ZD...T07...	⑥
7801600	PSE11R016SF8-2	2	16	10	8,5	14,5	27	8	10	ZD...T11...	③
7801601	PSE11R020SF10-3	3	20	10	10,5	18	33	10	14	ZD...T11...	④
7801602	PSE11R025SF12-4	4	25	10	12,5	23	35	12	17	ZD...T11...	⑤
7801603	PSE11R028SF12-4	4	28	10	12,5	23	35	12	17	ZD...T11...	⑤
7801604	PSE11R032SF16-5	5	32	10	17	28	40	16	22	ZD...T11...	⑥
7801605	PSE11R035SF16-5	5	35	10	17	28	40	16	22	ZD...T11...	⑥
7801606	PSE11R040SF16-6	6	40	10	17	28	40	16	22	ZD...T11...	⑥
7801607	PSE15R025SF12-2	2	25	14	12,5	23	35	12	17	ZD...T15...	⑤
7801608	PSE15R028SF12-2	2	28	14	12,5	23	35	12	17	ZD...T15...	⑤
7801609	PSE15R032SF16-3	3	32	14	17	28	40	16	22	ZD...T15...	⑥
7801610	PSE15R035SF16-3	3	35	14	17	28	40	16	22	ZD...T15...	⑥
7801611	PSE15R040SF16-4	4	40	14	17	28	40	16	22	ZD...T15...	⑥

Milling | Indexables



90 degrees

## Accessories and spare parts

Applicable cutter DC	EDP	Designation	Specification
PSE SS/SF 10 - 12 (ZDKT07)	7808098	FS18634P (Torx 6IP)	Clamping screw
PSE SS 16 - 26 (ZDKT07)	7808099	FS18637P (Torx 6IP)	Clamping screw
PSE SF 16 - 32 (ZDKT07)	7808099	FS18637P (Torx 6IP)	Clamping screw
PSE SS 10 - 26 (ZDKT07)	7808223	6IP-D (Torx 6IP)	Wrench
PSE SF 10 - 32 (ZDKT07)	7808223	6IP-D (Torx 6IP)	Wrench
16 - 40 (ZD-T11)	7808107	FS25656P (Torx 8IP)	Clamping screw
16 - 40 (ZD-T11)	7808225	8IP-D (Torx 8IP)	Wrench
25 - 40 (ZDKT15)	7808115	FS35686P (Torx 15IP)	Clamping screw
25 - 40 (ZDKT15)	7808228	15IP-D (Torx 15IP)	Wrench



# PSE INSERTS NEW SIZES

Milling | Indexable | Inserts

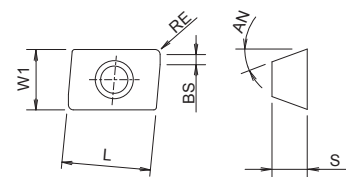

- 90° shoulder cutter
- 2 corners inserts with bottom notch

Milling | Indexables

Inserts

EDP	Designation	S	W1	L	AN	RE	BS	APMX	Grade	P		M		K		N		S		H		
										dry	⊖	dry	⊖	GG	GGG	dry	⊖	dry	⊖	dry	⊖	
NEW 7811112	ZDKT070302FR-NM	2,54	4	8,2	15	0,2	1,1		CK010								●					
NEW 7811113	ZDKT070304FR-NM	2,54	4	8,2	15	0,4	0,9		CK010								●					
NEW 7825127	ZDKT070304SR-GL	2,54	4	8,2	15	0,4	0,9		XC3030	●				○	○							
NEW 7825129	ZDKT070308SR-GL	2,54	4	8,2	15	0,8	0,5		XC3030	●				○	○							
NEW 7825128	ZDKT070304SR-GM	2,54	4	8,2	15	0,4	0,9		XC3030	●				○	○							
NEW 7825130	ZDKT070308SR-GM	2,54	4	8,2	15	0,8	0,5		XC3030	●				○	○							
NEW 7814123	ZDKT070304SR-GL	2,54	4	8,2	15	0,4	0,9		XP3035	●	●	○	○		○	○						
NEW 7814125	ZDKT070308SR-GL	2,54	4	8,2	15	0,8	0,5		XP3035	●	●	○	○		○	○						
NEW 7814124	ZDKT070304SR-GM	2,54	4	8,2	15	0,4	0,9		XP3035	●	●	○	○		○	○						
NEW 7814126	ZDKT070308SR-GM	2,54	4	8,2	15	0,8	0,5		XP3035	●	●	○	○		○	○						
NEW 7826121	ZDKT070304SR-GL	2,54	4	8,2	15	0,4	0,9		XP2025		○		●						○			
NEW 7826122	ZDKT070308SR-GL	2,54	4	8,2	15	0,8	0,5		XP2025		○		●						○			
NEW 7813117	ZDKT070304SR-GL	2,54	4	8,2	15	0,4	0,9		XP2040	○	○	○	○	●					○		○	
NEW 7813119	ZDKT070308SR-GL	2,54	4	8,2	15	0,8	0,5		XP2040	○	○	○	○	●					○		○	
NEW 7813116	ZDKT070302SR-GM	2,54	4	8,2	15	0,2	1,1		XP2040	○	○	○	○	●					○		○	
NEW 7813118	ZDKT070304SR-GM	2,54	4	8,2	15	0,4	0,9		XP2040	○	○	○	○	●					○		○	
NEW 7813120	ZDKT070308SR-GM	2,54	4	8,2	15	0,8	0,5		XP2040	○	○	○	○	●					○		○	
NEW 7812114	ZDKT070304SR-GM	2,54	4	8,2	15	0,4	0,9		XC1015					●	●							
NEW 7812115	ZDKT070308SR-GM	2,54	4	8,2	15	0,8	0,5		XC1015					●	●							
7814026	ZDKT11T308SR-GL	3,8	6,8	11	15	0,8	1,4	10	XP3035	●	●	○	○		○	○						
7814025	ZDKT11T304SR-GM	3,8	6,8	11	15	0,4	1,8	10	XP3035	●	●	○	○		○	○						
7814032	ZDKT11T308SR-GM	3,8	6,8	11	15	0,8	1,4	10	XP3035	●	●	○	○		○	○						
7814053	ZDKT11T312SR-GM	3,8	6,8	11	15	1,2	1	10	XP3035	●	●	○	○		○	○						
7814038	ZDKT11T320SR-GM	3,8	6,8	11	15	2	2,1	10	XP3035	●	●	○	○		○	○						
7814054	ZDKT11T330SR-GM	3,8	6,8	11	15	3	1,5	10	XP3035	●	●	○	○		○	○						
7814055	ZDKT11T340SR-GM	3,8	6,8	11	15	4	-	10	XP3035	●	●	○	○		○	○						
7814033	ZDKT11T308SR-GR	3,8	6,8	11	15	0,8	1,4	10	XP3035	●	●	○	○		○	○						
7825026	ZDKT11T308SR-GL	3,8	6,8	11	15	0,8	1,4	10	XP3030	●	●	○	○		○	○						
7825025	ZDKT11T304SR-GM	3,8	6,8	11	15	0,4	1,8	10	XP3030	●	●	○	○		○	○						
7825032	ZDKT11T308SR-GM	3,8	6,8	11	15	0,8	1,4	10	XP3030	●	●	○	○		○	○						
7825033	ZDKT11T308SR-GR	3,8	6,8	11	15	0,8	1,4	10	XP3030	●	●	○	○		○	○						
7828026	ZDKT11T308SR-GL	3,8	6,8	11	15	0,8	1,4	10	XP3025		●				○	○						
7828032	ZDKT11T308SR-GM	3,8	6,8	11	15	0,8	1,4	10	XP3025		●				○	○						
7828033	ZDKT11T308SR-GR	3,8	6,8	11	15	0,8	1,4	10	XP3025		●				○	○						
7813026	ZDKT11T308SR-GL	3,8	6,8	11	15	0,8	1,4	10	XP2040	○	○	○	○	●					○		●	
7813025	ZDKT11T304SR-GM	3,8	6,8	11	15	0,4	1,8	10	XP2040	○	○	○	○	●					○		●	
7813032	ZDKT11T308SR-GM	3,8	6,8	11	15	0,8	1,4	10	XP2040	○	○	○	○	●					○		●	
7813033	ZDKT11T308SR-GR	3,8	6,8	11	15	0,8	1,4	10	XP2040	○	○	○	○	●					○		●	
7826026	ZDKT11T308SR-GL	3,8	6,8	11	15	0,8	1,4	10	XP2025		○		●						○			
7826025	ZDKT11T304SR-GM	3,8	6,8	11	15	0,4	1,8	10	XP2025		○		●						○			
7826032	ZDKT11T308SR-GM	3,8	6,8	11	15	0,8	1,4	10	XP2025		○		●						○			
7815031	ZDKT11T308ER-SM	3,8	6,8	11	15	0,8	1,4	10	XC5035			●	○									○
7815027	ZDKT11T316ER-SM	3,8	6,8	11	15	1,6	0,8	10	XC5035			●	○									○
7816034	ZDKT11T304ER-SM	3,8	6,8	11	15	0,4	1,8	10	XC5040				○							○		
7816031	ZDKT11T308ER-SM	3,8	6,8	11	15	0,8	1,4	10	XC5040				○							○		
7816027	ZDKT11T316ER-SM	3,8	6,8	11	15	1,6	0,8	10	XC5040				○							○		
7827026	ZDKT11T308SR-GL	3,8	6,8	11	15	0,8	1,4	10	XC3020	●				○	○							
7827032	ZDKT11T308SR-GM	3,8	6,8	11	15	0,8	1,4	10	XC3020	●				○	○							
7827033	ZDKT11T308SR-GR	3,8	6,8	11	15	0,8	1,4	10	XC3020	●				○	○							
7812025	ZDKT11T304SR-GM	3,8	6,8	11	15	0,4	1,8	10	XC1015					●	●							
7812033	ZDKT11T308SR-GR	3,8	6,8	11	15	0,8	1,4	10	XC1015					●	●							
7824035	ZDKT11T308SR-HR	3,8	6,8	11	15	0,8	1,4	10	XP6015	○				○	○							●
7811048	ZDKT11T302FR-NM	3,8	6,8	11	15	0,2	2	10	CK010								●	●				
7811049	ZDKT11T304FR-NM	3,8	6,8	11	15	0,4	1,8	10	CK010								●	●				
7811024	ZDHT11T304FR-NM	3,5	6,8	11	15	0,4	1,8	10	CK010								●	●				
7811023	ZDKT11T308FR-NM	3,8	6,8	11	15	0,8	1,4	10	CK010								●	●				
7814057	ZDKT150508SR-GL	5,56	9,3	15	15	0,8	1,6	14	XP3035	●	●	○	○		○	○						
7814029	ZDKT150508SR-GM	5,56	9,3	15	15	0,8	1,6	14	XP3035	●	●	○	○		○	○						
7814077	ZDKT150512SR-GM	5,56	9,3	15	15	1,2	1,2	14	XP3035	●	●	○	○		○	○						
7814078	ZDKT150516SR-GM	5,56	9,3	15	15	1,6	0,8	14	XP3035	●	●	○	○		○	○						
7814079	ZDKT150520SR-GM	5,56	9,3	15	15	2	2,1	14	XP3035	●	●	○	○		○	○						



# PSE INSERTS NEW SIZES

Milling | Indexable | Inserts

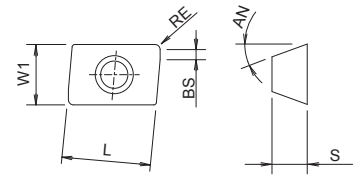

- 90° shoulder cutter
- 2 corners inserts with bottom notch

EDP	Designation	S	W1	L	AN	RE	BS	APMX	Grade	P		M		K		N		S		H	
										dry	☉	dry	☉	GG	GGG	dry	☉	dry	☉	dry	☉
7814080	ZDKT150530SR-GM	5,56	9,3	15	15	3	1,9	14	XP3035	☉	☉	☉	☉	☉	☉						
7814081	ZDKT150540SR-GM	5,56	9,3	15	15	4	1,1	14	XP3035	☉	☉	☉	☉	☉	☉						
7814082	ZDKT150550SR-GM	5,56	9,3	15	15	5	0,7	14	XP3035	☉	☉	☉	☉	☉	☉						
7814058	ZDKT150508SR-GR	5,56	9,3	15	15	0,8	1,6	14	XP3035	☉	☉	☉	☉	☉	☉						
7825057	ZDKT150508SR-GL	5,56	9,3	15	15	0,8	1,6	14	XP3030	☉	☉	☉	☉	☉	☉						
7825029	ZDKT150508SR-GM	5,56	9,3	15	15	0,8	1,6	14	XP3030	☉	☉	☉	☉	☉	☉						
7825058	ZDKT150508SR-GR	5,56	9,3	15	15	0,8	1,6	14	XP3030	☉	☉	☉	☉	☉	☉						
7813057	ZDKT150508SR-GL	5,56	9,3	15	15	0,8	1,6	14	XP2040	☉	☉	☉	☉	☉	☉			☉	☉	☉	☉
7813028	ZDKT150508SR-GR	5,56	9,3	15	15	0,8	1,6	14	XP2040	☉	☉	☉	☉	☉	☉			☉	☉	☉	☉
7813058	ZDKT150508SR-GR	5,56	9,3	15	15	0,8	1,6	14	XP2040	☉	☉	☉	☉	☉	☉			☉	☉	☉	☉
7826057	ZDKT150508SR-GL	5,56	9,3	15	15	0,8	1,6	14	XP2025	☉	☉	☉	☉	☉	☉			☉	☉	☉	☉
7826029	ZDKT150508SR-GM	5,56	9,3	15	15	0,8	1,6	14	XP2025	☉	☉	☉	☉	☉	☉			☉	☉	☉	☉
7815056	ZDKT150508ER-SM	5,56	9,3	15	15	0,8	1,6	14	XC5035			☉	☉					☉	☉	☉	☉
7816056	ZDKT150508ER-SM	5,56	9,3	15	15	0,8	1,6	14	XC5040			☉	☉					☉	☉	☉	☉
7812029	ZDKT150508SR-GM	5,56	9,3	15	15	0,8	1,6	14	XC1015					☉	☉						
7812058	ZDKT150508SR-GR	5,56	9,3	15	15	0,8	1,6	14	XC1015					☉	☉						
7824036	ZDKT150508SR-HR	5,56	9,3	15	15	0,8	1,6	14	XP6015	☉				☉	☉						☉
7811046	ZDKT150508FR-NM	5,56	9,3	15	15	0,8	1,6	14	CK010								☉				



# CUTTING CONDITIONS

Milling | Indexables | Cutting conditions

## PSE

90° shoulder cutter

	Work Material	Tensile Strength / Hardness	Insert Size												Grade
			ZDKT07...				ZD-T11...				ZDKT15...				
			ap:6mm ae:0,15D		ap:0,8mm ae:1,0D		ap:10mm ae:0,2D		ap:3mm ae:1,0D		ap:14mm ae:0,2D		ap:5mm ae:1,0D		
			Milling Speed Vc (m/min)	Feed per Tooth fz (mm/t)	Milling Speed Vc (m/min)	Feed per Tooth fz (mm/t)	Milling Speed Vc (m/min)	Feed per Tooth fz (mm/t)	Milling Speed Vc (m/min)	Feed per Tooth fz (mm/t)	Milling Speed Vc (m/min)	Feed per Tooth fz (mm/t)	Milling Speed Vc (m/min)	Feed per Tooth fz (mm/t)	
P	Mild Steel-Carbon Steel (S5400-S10C)	~180HB	180 (100~250)	0,1 (0,04~0,12)	180 (100~250)	0,08 (0,04~0,1)	180 (100~250)	0,25 (0,2~0,5)	180 (100~250)	0,12 (0,05~0,2)	180 (100~250)	0,3 (0,2~0,6)	180 (100~250)	0,15 (0,05~0,25)	XP3035
	Carbon Steel-Alloy Steel (S50C-SCM440)	~280HB	180 (100~250)	0,07 (0,04~0,1)	180 (100~250)	0,08 (0,04~0,1)	180 (100~250)	0,2 (0,15~0,4)	180 (100~250)	0,11 (0,05~0,2)	180 (100~250)	0,25 (0,15~0,5)	180 (100~250)	0,12 (0,05~0,2)	XP3035
	Die Steel (SKD11-SKD61)	~280HB	140 (80~180)	0,07 (0,04~0,1)	140 (80~180)	0,07 (0,04~0,1)	150 (80~200)	0,2 (0,15~0,4)	150 (80~200)	0,1 (0,05~0,18)	150 (80~200)	0,25 (0,15~0,5)	150 (80~200)	0,12 (0,05~0,2)	XP3035
M	Stainless Steel (Dry) (SUS304-SUS420)	~250HB	140 (80~180)	0,06 (0,04~0,08)	140 (80~180)	0,05 (0,04~0,08)	150 (80~200)	0,18 (0,15~0,4)	150 (80~200)	0,1 (0,05~0,18)	150 (80~200)	0,2 (0,15~0,45)	150 (80~200)	0,12 (0,05~0,2)	XC5035
	Stainless Steel (Coolant) (SUS304-SUS420)	~250HB	80 (60~100)	0,06 (0,04~0,08)	80 (60~100)	0,05 (0,04~0,08)	80 (60~120)	0,18 (0,15~0,4)	80 (60~120)	0,1 (0,05~0,18)	80 (60~120)	0,2 (0,15~0,45)	80 (60~120)	0,12 (0,05~0,2)	XP2040
K	Cast Iron (FC250)	~350N/mm <sup>2</sup>	180 (100~300)	0,1 (0,04~0,12)	180 (100~300)	0,1 (0,04~0,12)	180 (100~300)	0,25 (0,15~0,5)	180 (100~300)	0,12 (0,05~0,2)	180 (100~300)	0,3 (0,2~0,6)	180 (100~300)	0,15 (0,05~0,25)	XC1015
	Ductile Cast Iron (FCD400)	~800N/mm <sup>2</sup>	180 (100~300)	0,07 (0,04~0,1)	180 (100~300)	0,06 (0,04~0,08)	180 (100~250)	0,15 (0,1~0,4)	180 (100~250)	0,12 (0,05~0,2)	180 (100~250)	0,2 (0,15~0,5)	180 (100~250)	0,15 (0,05~0,25)	XC1015
N	Aluminium Alloys	~13%Si	300 (200~1,500)	0,15 (0,04~0,3)	300 (200~1,500)	0,12 (0,04~0,2)	300 (200~1,500)	0,3 (0,2~0,5)	300 (200~1,500)	0,15 (0,1~0,25)	300 (200~1,500)	0,35 (0,2~0,6)	300(200~1,500)	0,18 (0,1~0,3)	CK010
S	Heat Resistant Alloys (Wet) (Inconel 718)	-	35 (25~60)	0,07 (0,04~0,1)	35 (25~60)	0,06 (0,04~0,08)	35 (25~60)	0,15 (0,1~0,3)	35 (25~60)	0,1 (0,05~0,15)	35 (25~60)	0,2 (0,1~0,3)	35 (25~60)	0,12 (0,05~0,15)	XC5040
	Titanium Alloy (Wet) (Ti-6Al-4V)	-	45 (35~70)	0,07 (0,04~0,1)	45 (35~70)	0,07 (0,04~0,1)	40 (30~120)	0,18 (0,1~0,35)	40 (30~120)	0,1 (0,08~0,25)	40 (30~120)	0,22 (0,1~0,35)	40 (30~120)	0,12 (0,08~0,25)	XC5040
H	Pre-hardened Steel (NAK80)	40~43HRC	100 (40~150)	0,08 (0,04~0,12)	100 (40~150)	0,06 (0,04~0,08)	100 (40~150)	0,18 (0,1~0,3)	90 (40~150)	0,1 (0,08~0,2)	100 (40~150)	0,22 (0,1~0,35)	90 (40~150)	0,12 (0,08~0,25)	XP6015
	Steel for Die Casting (DAC55-DH31)	43~48HRC	80 (40~100)	0,06 (0,03~0,08)	80 (40~100)	0,06 (0,03~0,08)	80 (40~120)	0,12 (0,08~0,2)	70 (40~120)	0,08 (0,06~0,15)	80 (40~120)	0,15 (0,08~0,25)	70 (40~120)	0,1 (0,06~0,2)	XP6015
	Hardened Steel (SKD11)	50~55HRC	60 (40~70)	0,06 (0,03~0,08)	60 (40~70)	0,06 (0,03~0,08)	60 (40~90)	0,1 (0,05~0,2)	50 (40~90)	0,06 (0,05~0,1)	60 (40~90)	0,12 (0,05~0,2)	50 (40~90)	0,08 (0,05~0,12)	XP6015

## Maximum Ramping Angle (E) & Helical Angle (P)

Insert Size	ZDKT07...				ZD-T11...				ZDKT15...				
	D	Ramping Angle E°	Helical Milling (mm)		Helical Angle P°	Ramping Angle E°	Helical Milling (mm)		Helical Angle P°	Ramping Angle E°	Helical Milling (mm)		Helical Angle P°
			D Min.	D Max.			D Min.	D Max.			D Min.	D Max.	
10	6	14	19	4,5	-	-	-	-	-	-	-	-	
12	4,5	17	23	2,2	-	-	-	-	-	-	-	-	
16	2,8	25	31	1,1	10,8	18	29	9,8	-	-	-	-	
17	2,6	27	33	1	9,8	22	31	7,0	-	-	-	-	
18	-	-	-	-	9,8	22	33	7,0	-	-	-	-	
20	2,1	33	39	0,8	9,8	30	37	7,0	-	-	-	-	
21	2	35	41	0,7	8,5	32	39	4,5	-	-	-	-	
22	-	-	-	-	7,5	34	41	4,5	-	-	-	-	
25	1,6	43	49	0,5	7,5	40	47	4,5	9,5	37	48	7,5	
26	1,5	45	51	0,5	6,8	42	49	4,2	8,3	38	50	6,0	
28	-	-	-	-	6,3	46	53	3,9	8,3	39	54	5,6	
30	-	-	-	-	5,5	50	57	3,4	7,4	43	58	5,3	
32	1,1	57	63	0,4	4,8	53	61	3,2	6,8	47	62	5,0	
33	-	-	-	-	4,5	56	63	3,0	6,3	49	64	4,2	
35	-	-	-	-	3,2	60	67	2,5	5,9	53	68	3,8	
40	-	-	-	-	2,9	72	77	2,2	5,1	63	78	3,2	
50	-	-	-	-	2,2	93	98	1,7	2,5	86	98	2,5	
63	-	-	-	-	1,8	118	123	1,5	2,5	111	124	1,5	
80	-	-	-	-	1,4	152	157	1,0	2,0	147	158	1,3	
100	-	-	-	-	-	-	-	-	1,5	190	198	1,1	
125	-	-	-	-	-	-	-	-	0,9	240	248	0,9	

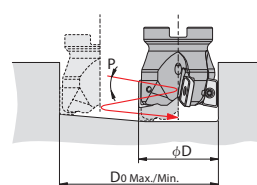
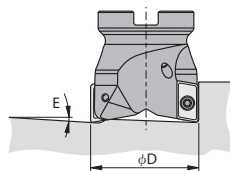

Milling | Indexables

Cutting Conditions

# CUTTING CONDITIONS

Milling | Indexables | Cutting conditions

## PSE

For sliding heads lathes

	Work Material	Tensile Strength / Hardness	Insert Size			
			ZDKT07...			
			ap:2mm ae:0,7D		ap:0,5mm ae:1,0D	
			Milling Speed Vc (m/min)	Feed per Tooth fz (mm/t)	Milling Speed Vc (m/min)	Feed per Tooth fz (mm/t)
P	Mild Steel-Carbon Steel (S5400-S10C)	~180HB	60 (40~80)	0,07 (0,03~0,1)	60 (40~80)	0,04 (0,02~0,06)
	Carbon Steel-Alloy Steel (S50C-SCM440)	~280HB	60 (40~80)	0,07 (0,03~0,1)	60 (40~80)	0,04 (0,02~0,06)
	Die Steel (SKD11-SKD61)	~280HB	60 (40~80)	0,07 (0,03~0,1)	60 (40~80)	0,04 (0,02~0,06)
M	Stainless Steel (Dry) (SUS304-SUS420)	~250HB	50 (40~70)	0,07 (0,03~0,1)	50 (40~70)	0,04 (0,02~0,05)
	Stainless Steel (Coolant) (SUS304-SUS420)	~250HB	40 (20~60)	0,05 (0,03~0,06)	40 (20~60)	0,04 (0,02~0,05)
K	Cast Iron (FC250)	~350N/mm <sup>2</sup>	60 (40~80)	0,07 (0,03~0,1)	60 (40~80)	0,05 (0,02~0,08)
	Ductile Cast Iron (FCD400)	~800N/mm <sup>2</sup>	60 (40~80)	0,07 (0,03~0,1)	60 (40~80)	0,05 (0,02~0,08)
N	Aluminium Alloys	~13%Si	190 (80~300)	0,08 (0,03~0,12)	190 (80~300)	0,07 (0,03~0,1)
S	Heat Resistant Alloys (Wet) (Inconel 718)	—	35 (20~50)	0,05 (0,03~0,06)	35 (20~50)	0,04 (0,02~0,05)
	Titanium Alloy (Wet) (Ti-6Al-4V)	—	40 (20~60)	0,05 (0,03~0,06)	40 (20~60)	0,04 (0,02~0,05)
H	Pre-hardened Steel (NAK80)	40~43HRC	50 (40~70)	0,07 (0,03~0,1)	50 (40~70)	0,04 (0,02~0,05)
	Steel for Die Casting (DAC55-DH31)	43~48HRC	40 (30~50)	0,05 (0,03~0,08)	40 (30~50)	0,04 (0,03~0,06)
	Hardened Steel (SKD11)	50~55HRC	40 (30~50)	0,05 (0,03~0,08)	40 (30~50)	0,04 (0,03~0,06)

The above cutting conditions are to be used as general guidelines. Adjustments may be necessary depending on actual cutting condition



# CUTTING DATA

## Long tool life on Inconel 718

Tool	<b>PSE11R032SS32-5S (Ø32x5)</b>	Competitor
Insert Grade	SPMT070305SR-GM (XC3020)	Coated carbide insert
Work Material	Inconel 718 (45HRC)	
Cutting Speed	30m/min (298min <sup>-1</sup> )	25m/min (248min <sup>-1</sup> )
Feed	120mm/min (0,08mm/t)	80mm/min (0,08mm/t)
Depth of Cut	a <sub>p</sub> =1mm a <sub>e</sub> =20mm	a <sub>p</sub> =1mm a <sub>e</sub> =20mm
Coolant	Water-Soluble	
Machine	Vertical Machining Center	

Our product was able to mill at conditions that were 50% higher than those for competitors' tools. It provided double the durability with normal wear and was able to continue milling.

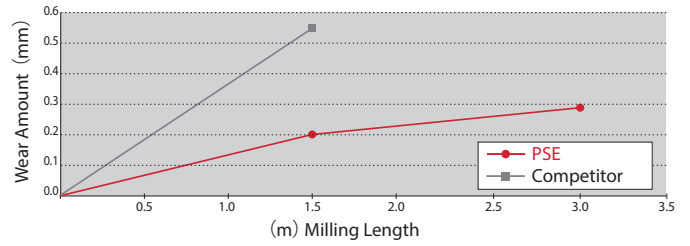

After 1.5m of milling

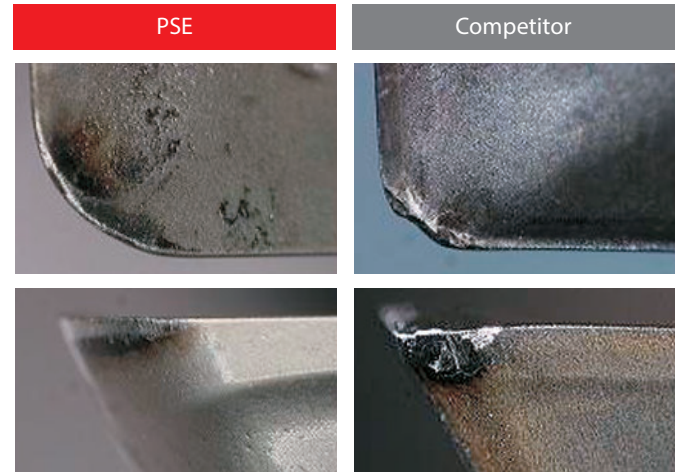

## Long tool life on NAK80 (40HRC)

Tool	<b>PSE11R020SS20-3S (Ø20x3)</b>	Competitor
Insert Grade	ZDKT11T308SR-GL (XP2040)	Coated carbide insert
Work Material	NAK80 (40HRC)	
Cutting Speed	130m/min (2.070min <sup>-1</sup> )	
Feed	1.400mm/min (0,23mm/t)	
Depth of Cut	a <sub>p</sub> =0,3mm a <sub>e</sub> =10mm	
Coolant	Air Blow	
Machine	Vertical Machining Center	

The competitor's tool chipped, but under the same conditions, the PSE did not exhibit any chipping, performed stably, and provided approximately double the durability.

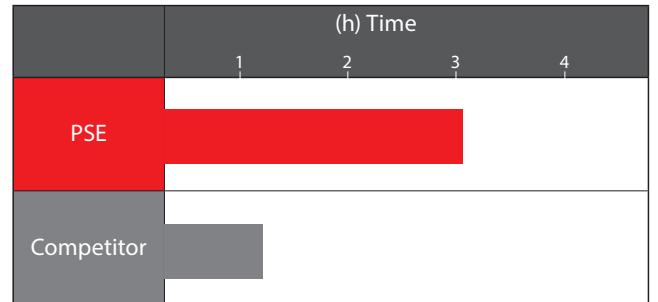

Milling | Indexables

Cutting Data

# CUTTING DATA

## Rough milling of die-casting dies

Tool	PHC09R050M22-5 (Ø50x5)	Competitor
Insert Grade	SDMT09T308SR-GM (XP2040)	Coated carbide insert
Work Material	SKD61 (48 HRC)	
Cutting Speed	80m/min (510min <sup>-1</sup> )	110m/min (700min <sup>-1</sup> )
Feed	1.360mm/min (0.53mm/t)	800mm/min (0.28mm/t)
Depth of Cut	ap=0.5mm ae=25mm	
Coolant	Air Blow	
Machine	Horizontal Machining Center	

In comparison to the competitors, the PSE (XC3030) has much great wear resistance, which leads to longer tool life.

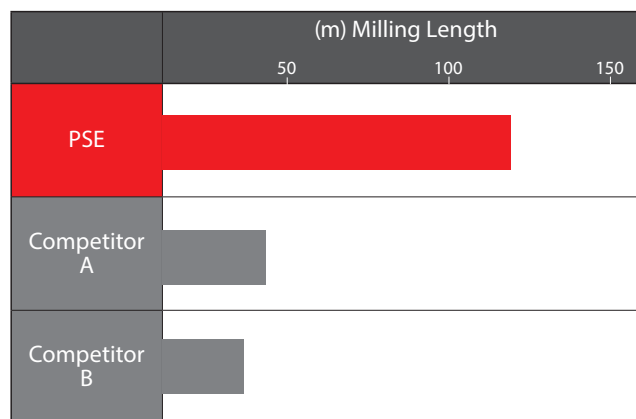
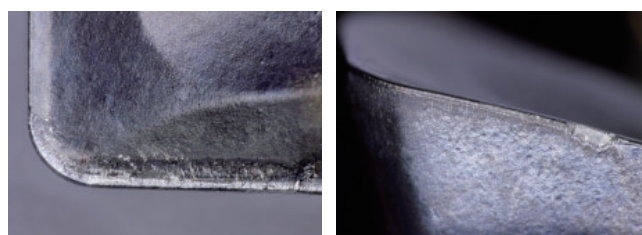

Photo after milling 128m



## Face milling of machine parts

Tool	PHC12R050M22-4 (Ø50x4)	Competitor
Insert Grade	ZDKT150508SR-GM (XP2040)	Coated carbide insert
Work Material	SUS304	
Cutting Speed	150m/min (478min <sup>-1</sup> )	
Feed	720mm/min (0,15mm/t)	500mm/min (0,15mm/t)
Depth of Cut	ap=1mm ae=60mm	
Coolant	Water-Soluble	
Machine	Horizontal Machining Center (BT40) Horizontal Machining Center	
Cutting Volume	43.2cm <sup>3</sup> /min	30cm <sup>3</sup> /min

This process consisted of intermittent face milling a surface with multiple holes, and our product was able to mill with 1.4 times the efficiency of the competitor's tool. Moreover, it inhibited the generation of heat, reducing the distortion of the workpiece as well as the effects passed on to the subsequent process.

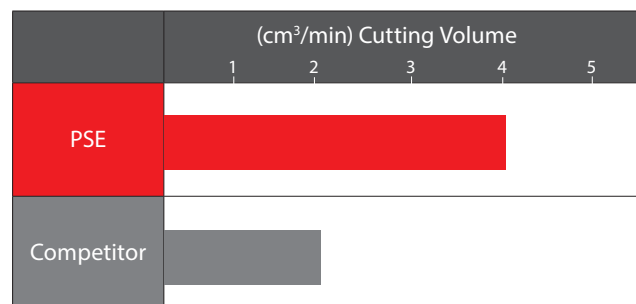

# CUTTING DATA

## Groove milling of a nozzle piece

Tool	PSE11R020SS20-3S (Ø20x3)	Competitor
Insert Grade	ZDKT11T308ER-SM (XC5040)	Coated carbide insert
Work Material	SUS630	
Cutting Speed	160 m/min (2.548 min <sup>-1</sup> )	
Feed	510 mm/min (0,07 mm/t)	
Depth of Cut	ap=2mm ae=20mm	
Coolant	Water-Soluble	
Machine	Compound Machine	

This process consists of groove milling in stainless steel. The competitor's tool caused the chips to jam, resulting in premature breakage of the tool. The PSE, in contrast, evacuated chips in a stable manner and could mill 10 workpieces, a significant improvement.

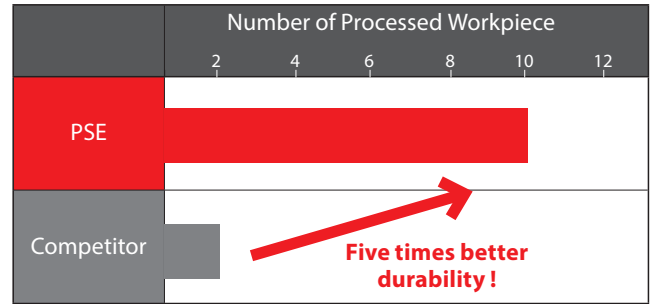

## Long life milling of a chamber

Tool	PSE15R080M25.4-8 (Ø80x8)	Competitor
Insert Grade	ZDKT150508SR-GM (XP2040)	Coated carbide insert
Work Material	SUS304	
Cutting Speed	180 m/min (717 min <sup>-1</sup> )	
Feed	700 mm/min (0,12 mm/t)	
Depth of Cut	ap=1 mm ae=60 mm	
Coolant	Air Blow	
Machine	Horizontal Machining Center	

This process consisted of dry milling in stainless steel. A competitor's tool and the PSE were compared in face milling the surface of a chamber opening under identical conditions. The competitor's tool broke prematurely, and was not able to continue. However, the PSE was able to attain more than double the durability.

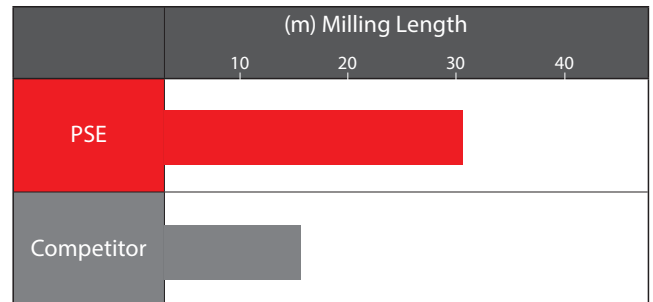

# CUTTING DATA

## Rough milling of aircraft parts

Tool	<b>PSE11R025SS25-4S (Ø25x4)</b>	Competitor
Insert Grade	ZDKT11T308ER-SM(XC5040)	Coated carbide insert
Work Material	Titanium alloy	
Cutting Speed	40 m/min (510 min <sup>-1</sup> )	
Feed per Tooth	160 mm/min (0,08 mm/t)	
Depth of Cut	ap=5 mm ae=10 mm	
Coolant	Water-Soluble	
Machine	Horizontal machining center	

A competitor's product and the PSE were compared in the rough milling of aircraft parts under identical conditions. The competitor's product chipped, but the PSE wore normally and attained 1.5 times the durability.

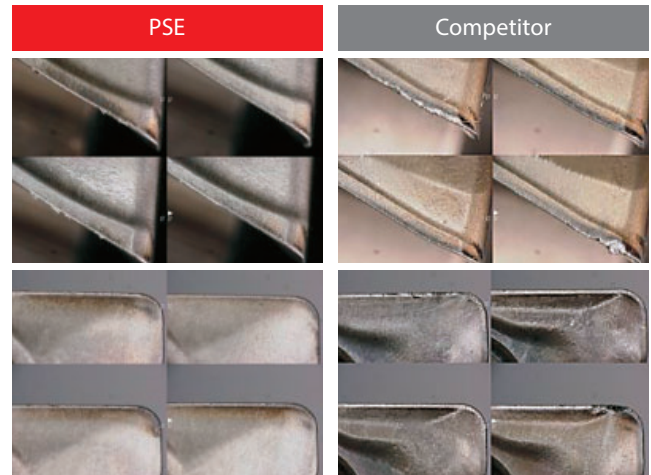
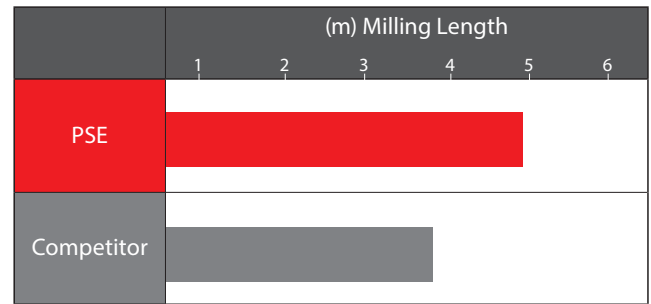

## Internal test DH31S (48HRC)

Tool	<b>PSE11R032SS32-3S (Ø32x3)</b>	Competitor
Insert Grade	ZDKT11T308SR-HR (XP6015)	Coated carbide insert
Work Material	DH31S (48HRC)	
Cutting Speed	50 m/min (497 min <sup>-1</sup> )	
Feed per Tooth	150 mm/min (0,1 mm/t)	
Depth of Cut	ap=5 mm ae=1 mm	
Coolant	Air Blow	
Machine	Vertical machining center	

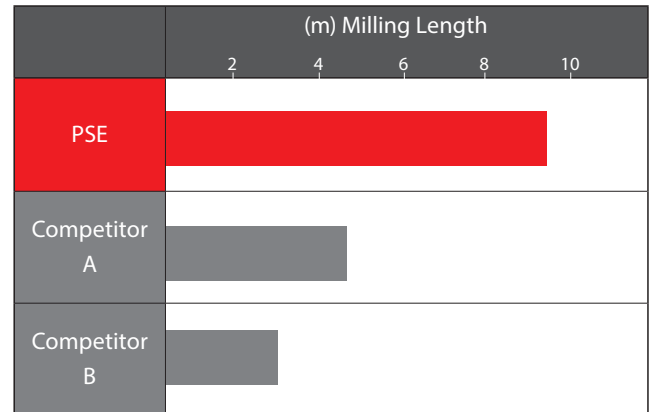

## Stable machining of padding

Tool	<b>PSE15R032SS32-3S (Ø32x3)</b>	Competitor
Insert Grade	ZDKT11T308SR-HR (XP6015)	Coated carbide insert
Work Material	Padding (56HRC)	
Cutting Speed	30 m/min (497 min <sup>-1</sup> )	
Feed per Tooth	110 mm/min (0,12 mm/t)	
Depth of Cut	ap=11 mm ae= 5~20 mm	
Coolant	Air Blow	
Machine	Vertical machining center	

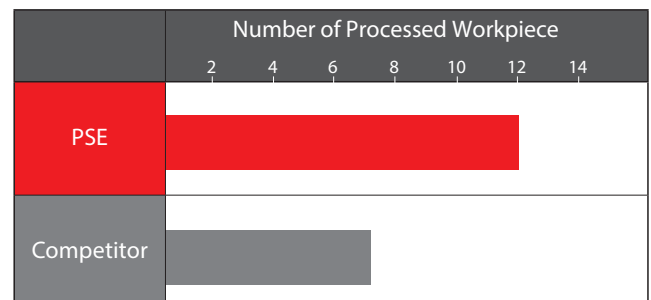

The competitor tool exhibited frequent insert breakage, which is an indicator for instability. OSG's PSE (XP6015), on the other hand, demonstrated consistent performance with 1.7 times the durability versus the competition.



# KEY FEATURES: PHOENIX PSEL

**1** 90° shoulder cutter with long neck of cut

**2** 2 corners inserts with bottom notch

**3** Cylindrical type





## Optimized insert arrangement

Variable axial rake angle (AR) suppress vibration which enables low-resistance machining.

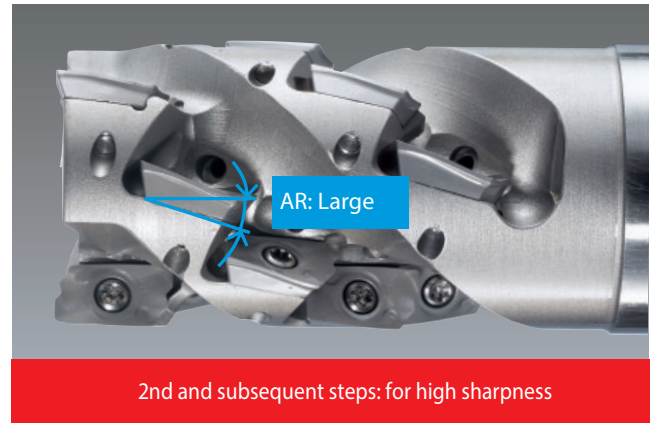
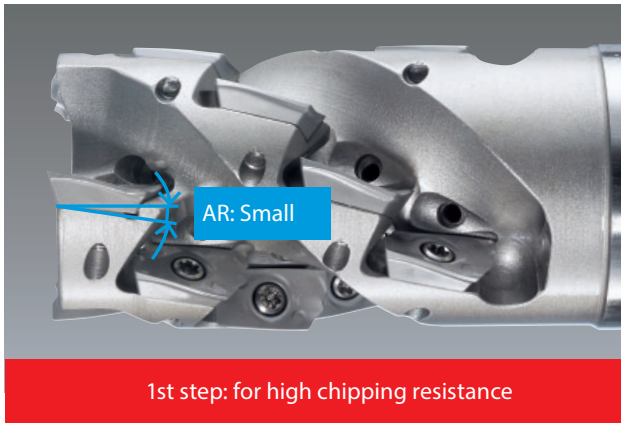

## Securely clamped inserts at the tip

Avoids sudden chipping and enables stable machining

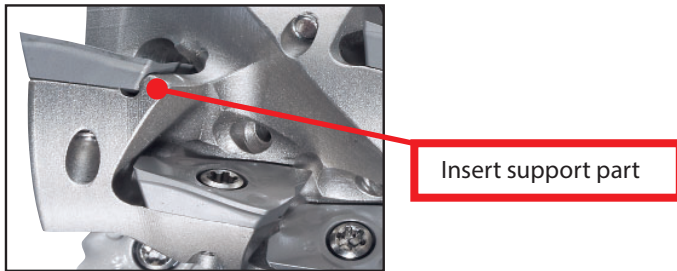

## A special lead groove and oil hole for every insert seat enable excellent chip ejection

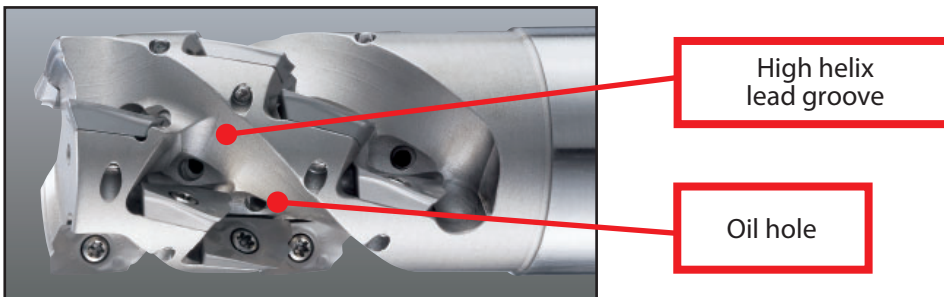

## Enables to simplify tool management, as inserts for PSEL are interchangeable with those for PSE.

A wide variety of inserts cover the various types of machining

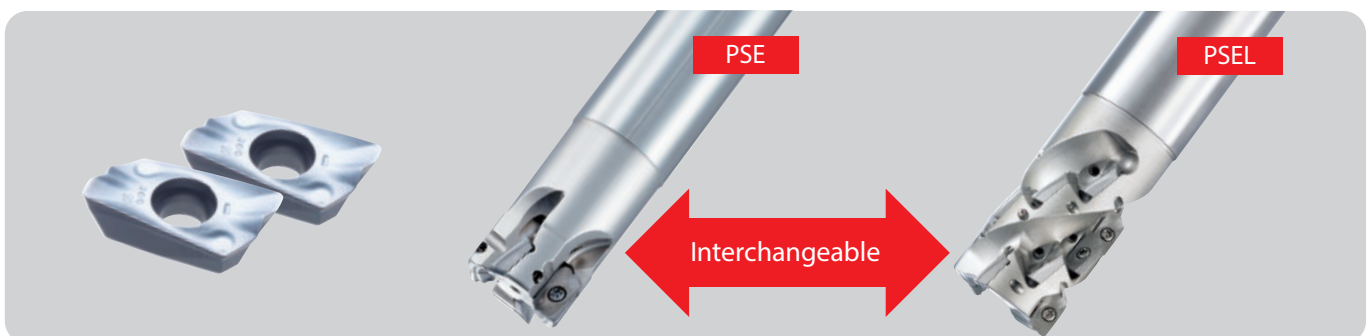





# CUTTING CONDITIONS

Milling | Indexables | Cutting conditions

## PSEL

90° shoulder cutter

	Work Material	Tensile Strength / Hardness	Insert Size				Grade
			ZD-T11...		ZDKT15...		
			Milling Speed Vc (m/min)	Feed per Tooth fz (mm/t)	Milling Speed Vc (m/min)	Feed per Tooth fz (mm/t)	
<b>P</b>	Mild Steel-Carbon Steel (SS400-S10C)	~180HB	160 (100~200)	0,25 (0,2~0,4)	160 (100~200)	0,3 (0,2~0,4)	XP3035
	Carbon Steel-Alloy Steel (S50C-SCM440)	~280HB	150 (100~200)	0,2 (0,15~0,3)	150 (100~200)	0,25 (0,15~0,3)	XP3035
	Die Steel (SKD11-SKD61)	~280HB	130 (80~180)	0,2 (0,15~0,3)	130 (80~180)	0,25 (0,15~0,3)	XP3035
<b>M</b>	Stainless Steel (Dry) (SUS304-SUS420)	~250HB	150 (100~200)	0,12 (0,1~0,3)	150 (100~200)	0,15 (0,1~0,3)	XC5035
	Stainless Steel (Coolant) (SUS304-SUS420)	~250HB	80 (60~120)	0,12 (0,1~0,3)	80 (60~120)	0,15 (0,1~0,3)	XP2040
<b>K</b>	Cast Iron (FC250)	~350N/mm <sup>2</sup>	160 (100~300)	0,2 (0,2~0,35)	160 (100~300)	0,25 (0,2~0,35)	XC1015
	Ductile Cast Iron (FCD400)	~800N/mm <sup>2</sup>	160 (100~250)	0,15 (0,2~0,3)	160 (100~250)	0,2 (0,2~0,3)	XC1015
<b>N</b>	Aluminium Alloys	~13%Si	300 (200~1.000)	0,25 (0,1~0,4)	300 (200~1.000)	0,3 (0,1~0,4)	CK010
<b>S</b>	Heat Resistant Alloys (Wet) (Inconel 718)	-	35 (25~60)	0,15 (0,1~0,3)	35 (25~60)	0,18 (0,1~0,3)	XC5040
	Titanium Alloy (Wet) (Ti-6Al-4V)	-	40 (30~120)	0,15 (0,1~0,3)	40 (30~120)	0,18 (0,1~0,3)	XC5040
<b>H</b>	Pre-hardened Steel (NAK80)	40~43HRC	100 (40~150)	0,15 (0,1~0,3)	100 (40~150)	0,18 (0,1~0,3)	XP6015
	Steel for Die Casting (DAC55-DH31)	43~48HRC	60 (40~120)	0,12 (0,05~0,2)	60 (40~120)	0,15 (0,05~0,2)	XP6015

## Maximum Ramping Angle (E) & Helical Angle (P)

Insert Size	ZD-T11...				ZDKT15...				
	D	Ramping Angle E°	Helical Milling (mm)		Helical Angle P°	Ramping Angle E°	Helical Milling (mm)		Helical Angle P°
			D Min.	D Max.			D Min.	D Max.	
16	10,8	18	29	9,8	-	-	-	-	
17	9,8	22	31	7,0	-	-	-	-	
18	9,8	22	33	7,0	-	-	-	-	
20	9,8	30	37	7,0	-	-	-	-	
21	8,5	32	39	4,5	-	-	-	-	
22	7,5	34	41	4,5	-	-	-	-	
25	7,5	40	47	4,5	9,5	37	48	7,5	
26	6,8	42	49	4,2	8,3	38	50	6,0	
28	6,3	46	53	3,9	8,3	39	54	5,6	
30	5,5	50	57	3,4	7,4	43	58	5,3	
32	4,8	53	61	3,2	6,8	47	62	5,0	
33	4,5	56	63	3,0	6,3	49	64	4,2	
35	3,2	60	67	2,5	5,9	53	68	3,8	
40	2,9	72	77	2,2	5,1	63	78	3,2	
50	2,2	93	98	1,7	2,5	86	98	2,5	
63	1,8	118	123	1,5	2,5	111	124	1,5	
80	1,4	152	157	1,0	2,0	147	158	1,3	
100	-	-	-	-	1,5	190	198	1,1	
125	-	-	-	-	0,9	240	248	0,9	

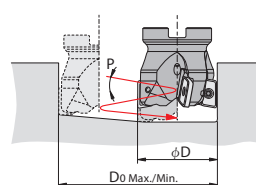
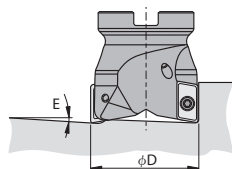

Milling | Indexables

Cutting conditions

# CUTTING DATA

## Side milling of the internal circumference of FCD450 machine parts with casting surface

Tool	<b>PSEL11R032SS32-3-45 (Ø32x3)</b>	Competitor (Ø32x2)
Insert Grade	ZDKT11T308SR-GR (XP3035)	Coated carbide insert
Work Material	FCD450	
Cutting Speed	100m/min (995min <sup>-1</sup> )	80m/min (795min <sup>-1</sup> )
Feed	600mm/min (0,2mm/t)	240mm/min (0,15mm/t)
Depth of Cut	$a_p=33\text{mm}$ $a_e=5\text{mm}$	
Coolant	Water-Soluble	
Overhang Length	200 mm	
Machine	Vertical Machining Center	

The machining time was reduced by 60% compared with the competitor's product. The sound was low with the stable machining. Its wear after machining 30 workpieces was minimal, and sudden chipping, which was occurred by the competitor's product, was unlikely to happen.

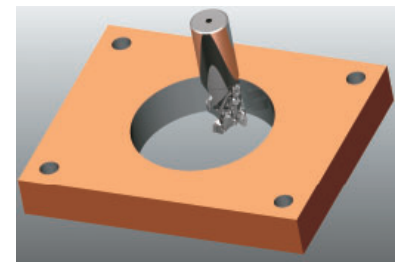
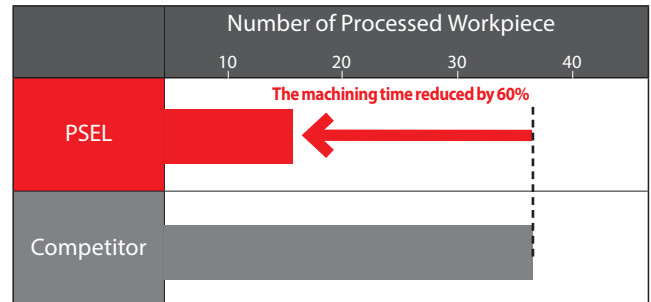

## Side milling of pre-hardened steel machine parts

Tool	<b>PSEL11R040SS42-3-37 (Ø40x3)</b>	Competitor
Insert Grade	ZDKT11T308SR-GR (XP2040)	Coated carbide insert
Work Material	NAK80 (45HRC)	
Cutting Speed	150 m/min (1.200 min <sup>-1</sup> )	
Feed	450 mm/min (0,13 mm/t)	240 mm/min (0,1 mm/t)
Depth of Cut	$a_p=25\text{ mm}$ $a_e=5\text{ mm}$	
Coolant	Water-Soluble	
Overhang Length	180 mm	
Machine	Horizontal Machining Center	

The machining time was reduced by 47% (PSEL: 10min. 8sec. per workpiece; the competitor's product: 19 min. per workpiece). Furthermore, the tool life became approximately 4 times, and sudden chipping, which was occurred by the competitor's product, was unlikely to happen.

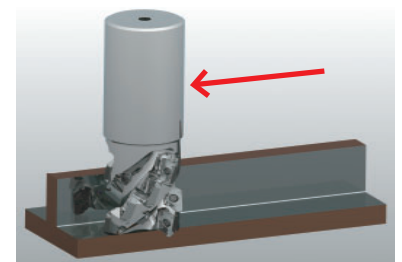
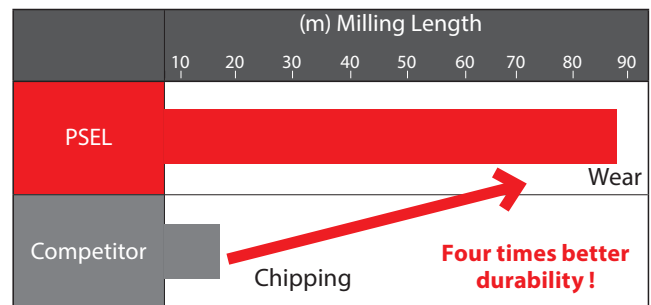

## Side milling of the outer circumference of titanium alloy aircraft parts

Tool	<b>PSEL15R063M27-3-50 (Ø63x3)</b>	Competitor (Ø63x4)
Insert Grade	ZDKT150508ER-SM (XC5040)	Coated carbide insert
Work Material	Ti-6Al-4V (35HRC)	
Cutting Speed	50 m/min (250 min <sup>-1</sup> )	
Feed	150 mm/min (0,2 mm/t)	150 mm/min (0,15 mm/t)
Depth of Cut	$a_p=21\sim45\text{ mm}$ $a_e=7,5\sim25\text{ mm}$	
Coolant	Water-Soluble	
Overhang Length	300 mm	
Machine	Horizontal Machining Center	

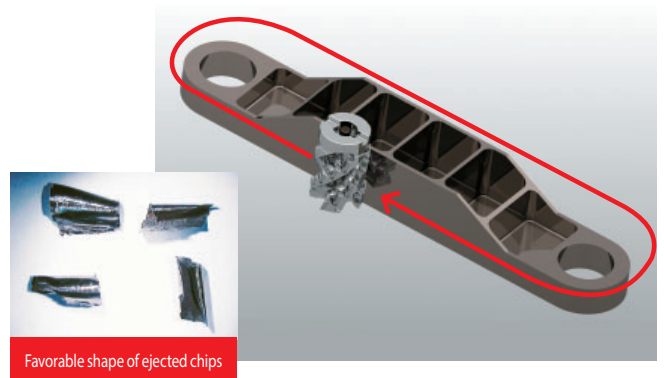

The PSEL achieved 3 times longer tool life (3 workpieces and welding wear after 276 mins) than the competitor tool (1 workpiece and chipping after 92 mins). Moreover, the PSEL was able to maintain consistent chip shape and minimize the risk of sudden chipping.

## SWEDEN

Branch office of OSG SCANDINAVIA  
Singelgatan 7  
212 28 Malmö  
Sweden  
Tel: +46 40 41 22 55  
osg@osg-scandinavia.com

## OSG SCANDINAVIA

(For Scandinavian countries)  
Langebjergvaenget 16  
4000 Roskilde  
Denmark  
Tel: +45 46 75 65 55  
osg@osg-scandinavia.com

## OSG NETHERLANDS

Bedrijfsweg 5  
3481 MG Harmelen  
The Netherlands  
Tel: +31 348 44 2764  
Fax: +31 348 44 2144  
info@osg-nl.com

## OSG UK

Kelsey Close, Attleborough Fields Ind Est,  
CV11 6RS, Nuneaton  
United Kingdom  
Tel: +44 1827 720 013  
sales@osg-uk.com

## OSG EUROPE LOGISTICS

Avenue Lavoisier 1  
B-1300 Z.I. Wavre - Nord  
Belgium  
Tel: +32 10 23 05 07  
Fax: +32 10 23 05 51  
info@osgeurope.com

## OSG BELUX

Avenue Lavoisier 1  
B-1300 Z.I. Wavre - Nord  
Belgium  
Tel: +32 10 23 05 11  
Fax: +32 10 23 05 31  
info@osg-belgium.com

## OSG IBÉRICA

Bekolarra 4  
E - 01010 Vitoria-Gasteiz  
Spain  
Tel: +34 945 242 400  
Fax: +34 945 228 883  
osg.iberica@osg-ib.com

## OSG FRANCE

Parc Icade, Paris Nord 2  
Immeuble "Le Rimbaud"  
22 Avenue des Nations  
CS66191 - 93420 Villepinte  
France  
Tel: +33 1 49 90 10 10  
Fax: +33 1 49 90 10 15  
sales@osg-france.com

## OSG ITALY

Via Ferrero, 65 A/B  
I - 10098 Rivoli  
Italy  
Tel: +39 0117705211  
Fax: +39 0117705215  
info@osg-italia.it



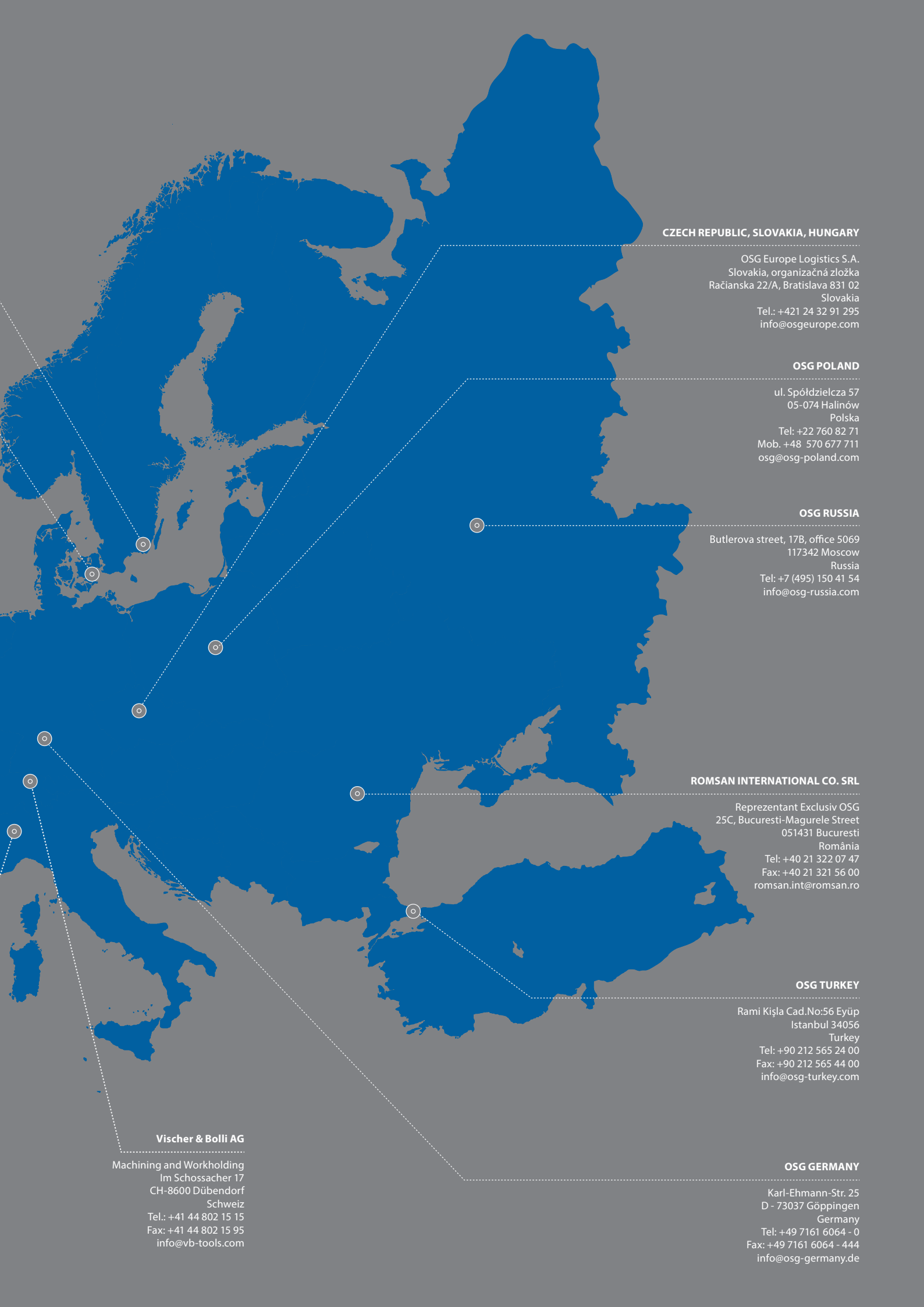

**CZECH REPUBLIC, SLOVAKIA, HUNGARY**

OSG Europe Logistics S.A.  
Slovakia, organizačná zložka  
Račianska 22/A, Bratislava 831 02  
Slovakia  
Tel.: +421 24 32 91 295  
info@osgeurope.com

**OSG POLAND**

ul. Spółdzielcza 57  
05-074 Halinów  
Polska  
Tel: +22 760 82 71  
Mob. +48 570 677 711  
osg@osg-poland.com

**OSG RUSSIA**

Butlerova street, 17B, office 5069  
117342 Moscow  
Russia  
Tel: +7 (495) 150 41 54  
info@osg-russia.com

**ROMSAN INTERNATIONAL CO. SRL**

Reprezentant Exclusiv OSG  
25C, Bucuresti-Magurele Street  
051431 Bucuresti  
România  
Tel: +40 21 322 07 47  
Fax: +40 21 321 56 00  
romsan.int@romsan.ro

**OSG TURKEY**

Rami Kışla Cad.No:56 Eyüp  
Istanbul 34056  
Turkey  
Tel: +90 212 565 24 00  
Fax: +90 212 565 44 00  
info@osg-turkey.com

**Vischer & Bolli AG**

Machining and Workholding  
Im Schossacher 17  
CH-8600 Dübendorf  
Schweiz  
Tel.: +41 44 802 15 15  
Fax: +41 44 802 15 95  
info@vb-tools.com

**OSG GERMANY**

Karl-Ehmann-Str. 25  
D - 73037 Göppingen  
Germany  
Tel: +49 7161 6064 - 0  
Fax: +49 7161 6064 - 444  
info@osg-germany.de



shaping your dreams

#### OSG EUROPE LOGISTICS

Avenue Lavoisier 1  
B-1300 Z.I. Wavre - Nord - Belgium  
Tel: +32 10 23 05 07  
Fax: +32 10 23 05 51  
info@osgeurope.com

#### OSG POLAND Sp. z.o.o.

Spółdzielcza 57  
05-074 Halinów - Poland  
Tel: +22 760 82 71  
Fax: +22 760 82 71  
osg@osg-poland.com

#### OSG TURKEY

Rami Kişla Cad.No:56 Eyüp  
Istanbul 34056 - Turkey  
Tel+90 212 565 24 00  
Fax: +90 212 565 44 00  
info@osg-turkey.com

#### OSG BELUX

Avenue Lavoisier 1  
B-1300 Z.I. Wavre - Nord - Belgium  
Tel: +32 10 23 05 11  
Fax: +32 10 23 05 31  
info@osg-belgium.com

#### OSG GERMANY

Karl-Ehmann-Str. 25  
D - 73037 Göppingen - Germany  
Tel: +49 7161 6064 - 0  
Fax: +49 7161 6064 - 444  
info@osg-germany.de

#### ROMSAN INTERNATIONAL CO. SRL

Reprezentant Exclusiv OSG  
25C, Bucuresti-Magurele Street  
051431 Bucuresti - România  
Tel: +40 21 322 07 47  
Fax: +40 21 321 56 00  
romsan.int@romsan.ro

#### OSG FRANCE

Parc Icade, Paris Nord 2  
Immeuble "Le Rimbaud"  
22 Avenue des Nations  
CS66191 - 93420 Villepinte - France  
Tel: +33 1 49 90 10 10  
Fax: +33 1 49 90 10 15  
sales@osg-france.com

#### OSG SCANDINAVIA

(For Scandinavian countries)  
Langebjergvaenget 16  
4000 Roskilde - Denmark  
Tel: +45 46 75 65 55  
Fax: +45 46 75 67 00  
osg@osg-scandinavia.com

#### AUSTRIA

Branch office of OSG GERMANY  
Messestraße 11  
A-6850 Dornbirn  
Tel: +49 7161 6064-0  
Fax: +49 7161 6064-444  
info@osg-germany.de

#### OSG NETHERLANDS

Bedrijfsweg 5 - 3481 MG Harmelen  
Tel: +31 348 44 2764  
Fax: +31 348 44 2144  
info@osg-nl.com

#### SWEDEN

Branch office of OSG SCANDINAVIA  
Singelgatan 7  
212 28 Malmö - Sweden  
Tel: +46 40 41 22 55  
osg@osg-scandinavia.com

#### OSG ITALIA

Via Ferrero, 65 A/B3  
I - 10098 Rivoli - Italy  
Tel: +39 0117705211  
Fax: +39 0117705215  
info@osg-italia.it

#### OSG UK

Kelsey Close, Attleborough Fields Ind Est,  
CV11 6RS, Nuneaton, United Kingdom.  
Tel: +44 1827 720 013  
uk\_sales@osg-uk.com

#### OSG IBERICA

Bekolarra 4  
E - 01010 Vitoria-Gasteiz - Spain  
Tel: +34 945 242 400  
Fax: +34 945 228 883  
osg.iberica@osg-ib.com

#### Vischer & Bolli AG

Machining and Workholding  
Im Schossacher 17  
CH-8600 Dübendorf  
T +41 44 802 15 15  
F +41 44 802 15 95  
info@vb-tools.com

#### CZECH, SLOVAKIA, HUNGARY

OSG Europe Logistics S.A.  
Slovakia organizacna zlozka  
Racianská 22/A, SK-83102 Bratislava  
Slovakia  
Tel. +421 24 32 91 295  
Orders-osgsvk@osgeurope.com

#### RUSSIA

Butlerova street, 17B, office 5069  
117342 Moscow - Russia  
Tel: +7 (495) 150 41 54  
info@osg-russia.com

#### OSG EUROPE LOGISTICS S.A.

01/2023 - All rights reserved. © OSG Europe 2023.

The contents of this catalogue are provided to you for viewing only. They are not intended for reproduction either in part or in whole in this or other medium. They cannot be copied, used to create derivation work or used for any reason, by means without the express, written permission of the copyright owner. If prices are stated, they are netto unit-prices and any eventual tax(es) have to be added. The company is not responsible for any printing error in technical, price and/or any other data.

Tool specifications subject to change without notice.

[www.osgeurope.com](http://www.osgeurope.com)